

ViewSonic®



CDM5500T Commercial Display User Guide

IMPORTANT: Please read this User Guide to obtain important information on installing and using your product in a safe manner, as well as registering your product for future service. Warranty information contained in this User Guide will describe your limited coverage from ViewSonic Corporation, which is also found on our web site at <http://www.viewsonic.com> in English, or in specific languages using the Regional selection box in the upper right corner of our website. "Antes de operar su equipo lea cuidadosamente las instrucciones en este manual"

Model No. VS16854

Thank you for choosing ViewSonic

As a world leading provider of visual solutions, ViewSonic is dedicated to exceeding the world's expectations for technological evolution, innovation, and simplicity. At ViewSonic, we believe that our products have the potential to make a positive impact in the world, and we are confident that the ViewSonic product you have chosen will serve you well.

Once again, thank you for choosing ViewSonic !



Compliance Information

NOTE: This section addresses all connected requirements and statements regarding regulations. Confirmed corresponding applications shall refer to nameplate labels and relevant markings on unit.

Federal Communication Commission Interference Statement

This device complies with Part 15 of the FCC Rules. Operation is subject to the following two conditions: (1) This device may not cause harmful interference, and (2) this device must accept any interference received, including interference that may cause undesired operation.

NOTE: This equipment has been tested and found to comply with the limits for a Class A digital device, pursuant to Part 15 of the FCC Rules. These limits are designed to provide reasonable protection against harmful interference in a residential installation. This equipment generates, uses and can radiate radio frequency energy and, if not installed and used in accordance with the instructions, may cause harmful interference to radio communications. However, there is no guarantee that interference will not occur in a particular installation. If this equipment does cause harmful interference to radio or television reception, which can be determined by turning the equipment off and on, the user is encouraged to try to correct the interference by one of the following measures:

- Reorient or relocate the receiving antenna.
- Increase the separation between the equipment and receiver.
- Connect the equipment into an outlet on a circuit different from that to which the receiver is connected.
- Consult the dealer or an experienced radio/TV technician for help.

FCC Caution: Any changes or modifications not expressly approved by the party responsible for compliance could void the user's authority to operate this equipment.

This transmitter must not be co-located or operating in conjunction with any other antenna or transmitter.

For Canada

CAN ICES-3 (A)/NMB-3(A)

Industry Canada Notice

This device complies with Canadian RSS-210. To prevent radio interference to the licensed service, this device is intended to be operated indoors and away from windows to provide maximum shielding. Equipment (or its transmitting antenna) that is installed outdoors is subject to licensing. The installer of this radio equipment must ensure that the antenna is located or pointed such that it does not emit RF field in excess of Health Canada limits for the general population; consult Safety Code 6, obtainable from Health Canada's website www.hc-sc.gc.ca/rpb.

Declaration of RoHS2 Compliance

This product has been designed and manufactured in compliance with Directive 2011/65/EU of the European Parliament and the Council on restriction of the use of certain hazardous substances in electrical and electronic equipment (RoHS2 Directive) and is deemed to comply with the maximum concentration values issued by the European Technical Adaptation Committee (TAC) as shown below:

Substance	Proposed Maximum Concentration	Actual Concentration
Lead (Pb)	0,1%	< 0,1%
Mercury (Hg)	0,1%	< 0,1%
Cadmium (Cd)	0,01%	< 0,01%
Hexavalent Chromium (Cr ⁶⁺)	0,1%	< 0,1%
Polybrominated biphenyls (PBB)	0,1%	< 0,1%
Polybrominated diphenyl ethers (PBDE)	0,1%	< 0,1%

Certain components of products as stated above are exempted under the Annex III of the RoHS2 Directives as noted below:

Examples of exempted components are:

- Mercury in cold cathode fluorescent lamps and external electrode fluorescent lamps (CCFL and EEFL) for special purposes not exceeding (per lamp):
 - Short length (≤ 500 mm): maximum 3.5 mg per lamp.
 - Medium length (> 500 mm and $\leq 1,500$ mm): maximum 5 mg per lamp.
 - Long length ($> 1,500$ mm): maximum 13 mg per lamp.
- Lead in glass of cathode ray tubes.
- Lead in glass of fluorescent tubes not exceeding 0.2% by weight.
- Lead as an alloying element in aluminium containing up to 0.4% lead by weight.
- Copper alloy containing up to 4% lead by weight.
- Lead in high melting temperature type solders (i.e. lead-based alloys containing 85% by weight or more lead).
- Electrical and electronic components containing lead in a glass or ceramic other than dielectric ceramic in capacitors, e.g. piezoelectronic devices, or in a glass or ceramic matrix compound.

Safety Precautions

FOR OPTIMUM PERFORMANCE, PLEASE NOTE THE FOLLOWING WHEN SETTING UP AND USING THE LCD COLOR MONITOR:

- DO NOT REMOVE MONITOR BACK COVER. There are no user serviceable parts inside and opening or removing covers may expose you to dangerous shock hazards or other risks. Refer all servicing to qualified service personnel.
- Do not spill any liquids into the cabinet or use your monitor near water.
- Do not insert objects of any kind into the cabinet slots, as they may touch dangerous voltage points, which can be harmful or fatal or may cause electric shock, fire or equipment failure.
- Do not place any heavy objects on the power cord. Damage to the cord may cause shock or fire.
- Do not place this product on a sloping or unstable cart, stand or table, as the monitor may fall, causing serious damage to the monitor.
- Do not place any objects onto the monitor and do not use the monitor outdoors.
- The inside of the fluorescent tube located within the LCD monitor contains mercury. Please follow the laws or rules of your municipality to dispose of the tube properly.
- Do not bend power cord.
- Do not use monitor in high temperature, humid, dusty, or oily areas.
- If monitor or glass is broken, do not come in contact with the liquid crystal and handle with care.
- Allow adequate ventilation around the monitor, so that heat can properly dissipate. Do not block ventilated openings or place the monitor near a radiator or other heat sources. Do not put anything on top of the monitor.
- The power cable connector is the primary means of detaching the system from the power supply. The monitor should be installed close to a power outlet, which is easily accessible.
- Handle with care when transporting. Save packaging for transporting.
- Please clean the holes of back cabinet to reject dirt and dust at least once a year because of set reliability.
- If using the cooling fan continuously, it's recommended to wipe holes a minimum of once a month.
- When installing the remote control batteries;
 - Align the batteries according to the (+) and (-) indications inside the case.
 - Align the (-) indication of the battery first inside the case.
- Usage of other than specified head- or earphones can result in hearing loss due to excessive sound pressures.

CAUTION:

Immediately unplug your monitor from the wall outlet and refer servicing to qualified service personnel under the following conditions:

- When the power supply cord or plug is damaged.
- If liquid has been spilled, or objects have fallen into the monitor.
- If the monitor has been exposed to rain or water.
- If the monitor has been dropped or the cabinet damaged.
- If the monitor does not operate normally by following operating instructions.

Recommended Use**CAUTION:**

- For optimum performance, allow 20 minutes for warm-up.
- Rest your eyes periodically by focusing on an object at least 5 feet away. Blink often.
- Position the monitor at a 90° angle to windows and other light sources to minimize glare and reflections.
- Clean the LCD monitor surface with a lint-free, nonabrasive cloth. Avoid using any cleaning solution or glass cleaner!
- Adjust the monitor's brightness, contrast and sharpness controls to enhance readability.
- Avoid displaying fixed patterns on the monitor for long periods of time to avoid image persistence (after image effects).
- Get regular eye checkups.

Ergonomics

To realize the maximum ergonomic benefits, we recommend the following:

- Use the preset Size and Position controls with standard signals.
- Use the preset Color Setting.
- Use non-interlaced signals.
- Do not use primary color blue on a dark background, as it is difficult to see and may produce eye fatigue due to insufficient contrast.

Table Of Contents

1. Unpacking and Installation	1	4.7.3. Signage Display	20
1.1. Unpacking	1	4.7.4. System Tools.....	20
1.2. Package Contents.....	1	4.7.5. Storage	20
1.3. Installation Notes.....	1	4.7.6. Apps.....	20
1.4. Installing and Removing Table Stands (optional)	2	4.7.7. Date & Time	20
1.5. Mounting on a Wall.....	3	4.7.8. Development Setting.....	21
1.6. Mounting in Portrait Position	4	4.7.9. About.....	21
2. Parts and Functions	5	5. OSD Menu.....	21
2.1. Control Panel	5	5.1. Settings	22
2.2. Input/Output Terminals	6	5.1.1. Picture menu.....	22
2.3. Remote Control	7	5.1.2. Screen menu.....	22
2.3.1. General functions.....	7	5.1.3. Audio menu.....	23
2.3.2. Inserting batteries in the remote control	8	5.1.4. PIP menu	24
2.3.3. Handling the remote control.	8	5.1.5. Config1 menu.....	24
2.3.4. Operating range of the remote control	8	5.1.6. Config2 menu.....	25
3. Connecting External Equipment	9	5.1.7. Advanced menu	26
3.1. Connecting External Equipment (DVD/VCR/VCD).....	9	6. USB device compatibility	33
3.1.1. Using HDMI video input	9	7. Input mode	34
3.2. Connecting a PC	9	8. Cleaning and Troubleshooting	35
3.2.1. Using VGA input.....	9	8.1. Cleaning	35
3.2.2. Using DVI input.....	10	8.2. Troubleshooting.....	36
3.2.3. Using HDMI input.....	10	9. Technical Specifications	37
3.2.4. Using DisplayPort input.....	11	9.1. CDM5500T	37
3.3. Connecting Audio Equipment.....	11	10. RS232 Protocol	39
3.3.1. Connecting an external audio device.....	11	10.1. Introduction	39
3.4. Connecting Multiple Displays in a Daisy-chain Configuration	12	10.2. Description	39
3.4.1. Display control connection .	12	10.2.1. Hardware specification ...	39
3.4.2. Digital video connection	12	10.2.2. Communication Setting...	39
3.5. IR connection	13	10.2.3. Command Message Reference	39
3.6. IR Pass-through Connection	13	10.3. Protocol	40
4. Operation	14	10.3.1. Set-Function Listing.....	40
4.1. Watch the Connected Video Source	14	10.3.2. Get-Function Listing.....	43
4.2. Change Picture Format	14	10.3.3. Remote Control Pass- through mode.....	46
4.3. Media Player	14	11. Other Information	49
4.3.1. Base settings in Display.....	14	Customer Support.....	49
4.3.2. Signage Manager.....	14	Limited Warranty	50
4.4. Web Browser.....	16	Mexico Limited Warranty	52
4.5. PDF Reader	17		
4.6. Custom.....	18		
4.7. Setting (Admin mode)	19		
4.7.1. Wi-Fi.....	19		
4.7.2. Ethernet	19		

Copyright Information

Copyright © ViewSonic® Corporation, 2017. All rights reserved.

ViewSonic®, the three birds logo, OnView, ViewMatch, and ViewMeter are registered trademarks of ViewSonic Corporation.

ENERGY STAR® is a registered trademark of the U.S. Environmental Protection Agency (EPA). As an ENERGY STAR® partner, ViewSonic Corporation has determined that this product meets the ENERGY STAR® guidelines for energy efficiency.

Disclaimer: ViewSonic Corporation shall not be liable for technical or editorial errors or omissions contained herein; nor for incidental or consequential damages resulting from furnishing this material, or the performance or use of this product.

In the interest of continuing product improvement, ViewSonic Corporation reserves the right to change product specifications without notice. Information in this document may change without notice.

No part of this document may be copied, reproduced, or transmitted by any means, for any purpose without prior written permission from ViewSonic Corporation.

Product Registration

To meet your future needs, and to receive any additional product information as it becomes available, please register your product on the Internet at:
www.viewsonic.com.

The ViewSonic® Wizard CD-ROM also provides an opportunity for you to print the registration form, which you may mail or fax to ViewSonic.

For Your Records

Product Name:	CDM5500T ViewSonic Commercial Display
Model Number:	VS16854
Document Number:	CDM5500T_UG_ENG Rev. 1A 12-28-16
Serial Number:	_____
Purchase Date:	_____

Product disposal at end of product life

ViewSonic respects the environment and is committed to working and living green. Thank you for being part of Smarter, Greener Computing.

Please visit ViewSonic website to learn more.

USA & Canada: <http://www.viewsonic.com/company/green/recycle-program/>

Europe: <http://www.viewsoniceurope.com/uk/support/recycling-information/>

Taiwan: <http://recycle.epa.gov.tw/recycle/index2.aspx>

1. Unpacking and Installation

1.1. Unpacking

- This product is packed in a carton, together with the standard accessories.
- Any other optional accessories will be packed separately.
- Due to the size and weight of this display it is recommended for two people to move it.
- After opening the carton, ensure that the contents are complete and in good condition.

1.2. Package Contents

Please verify that you received the following items with your package content:

- LCD display
- CD ROM
- Remote control with AAA batteries
- Quick Start Guide
- Power cord (1.8 m)
- RS232 cable (1.8 m)
- RS232 daisy chain cable (2.4mm-2.4mm)
- IR sensor cable
- DVI to VGA cable
- USB cable (Type A-B)

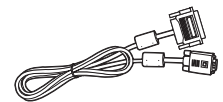

DVI to VGA cable

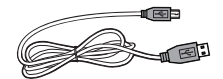

USB cable (Type A-B)

* The supplied power cord varies depending on destination.



For EU



For China

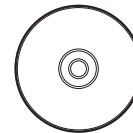

CD ROM



Quick Start Guide



For North America



For UK

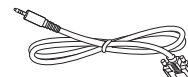

RS232 Cable

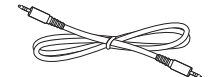

RS232 daisy chain cable

NOTES:

- For all other regions, apply a power cord that conforms to the AC voltage of the power socket and has been approved by and complies with the safety regulations of the particular country.
- Keep the package box and packing material for shipping the display.

1.3. Installation Notes

- Due to the high power consumption, always use the plug exclusively designed for this product. If an extended line is required, please consult your service agent.
- The product should be installed on a flat surface to avoid tipping. The distance between the back of the product and the wall should be maintained for proper ventilation. Avoid installing the product in the kitchen, bathroom or any other places with high humidity so as not to shorten the service life of the electronic components.
- The product can normally operate only under 2000 m in altitude. In installations at altitudes above 2000 m, some abnormalities may be experienced.

1.4. Installing and Removing Table Stands (optional)

Step 1- Put on the table

Lay a protective sheet on the table, which was wrapped around the display when it was packaged, beneath the screen surface so as not to scratch the screen face.

Step 2- Fix the tube to the display (by using M6xL41 screws)

Please refer to the following drawing to know the position of screws.

Step 3- Set up the stand (by using thumb)

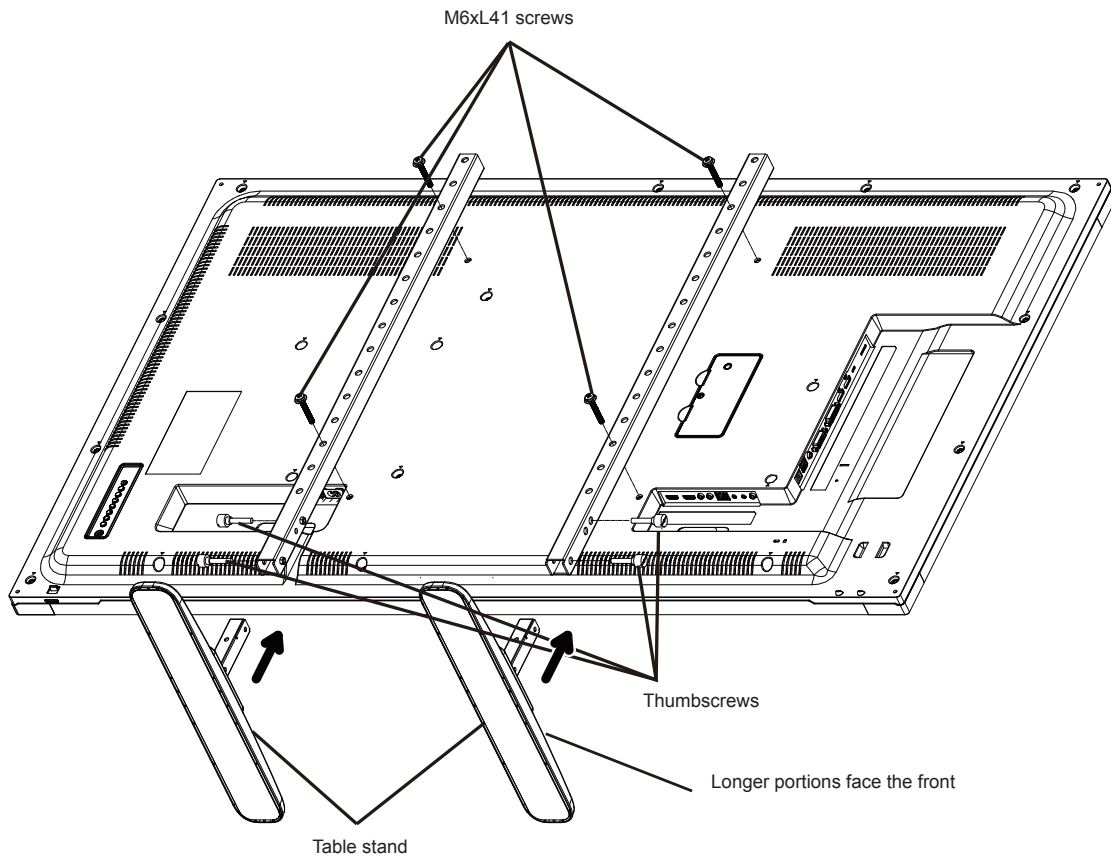

To remove table stands:

1. Power off the display.
2. Spread a protective sheet on a flat surface.
3. Place the display face-down on the protective sheet.
4. Remove screws using a screwdriver and place them in a safe place for reuse.

1.5. Mounting on a Wall

To mount this display to a wall, you will have to obtain a standard wall-mounting kit. We recommend using a mounting interface that complies with UL1678 standard in North America.

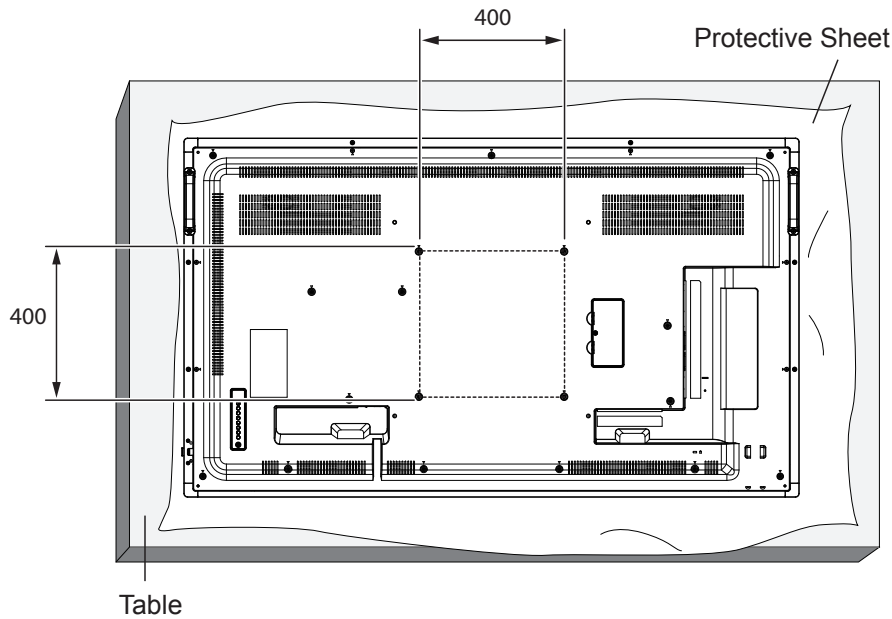

1. Lay a protective sheet on a table, which was wrapped around the display when it was packaged, beneath the screen surface so as not to scratch the screen face.
2. Ensure you have all accessories for mounting this display.
3. Follow the instructions that come with the base mounting kit. Failure to follow correct mounting procedures could result in damage to the equipment or injury to the user or installer. Product warranty does not cover damage caused by improper installation.
4. For the wall-mounting kit, use mounting screws and tighten them securely:

Model	VESA Size (mm)	Mounting Screws (X=Thickness of wall-mount plate)
CDM5500T	400 × 400	M6 × (10 + X)

Caution:

To prevent the display from falling:

- To lessen the probability of injury and damage resulting from fall of the display in case of earthquake or other natural disaster, be sure to consult the bracket manufacturer for installation location.

Enclosure Ventilation Requirements

To allow heat to disperse, leave space between surrounding objects as shown in the diagram below.

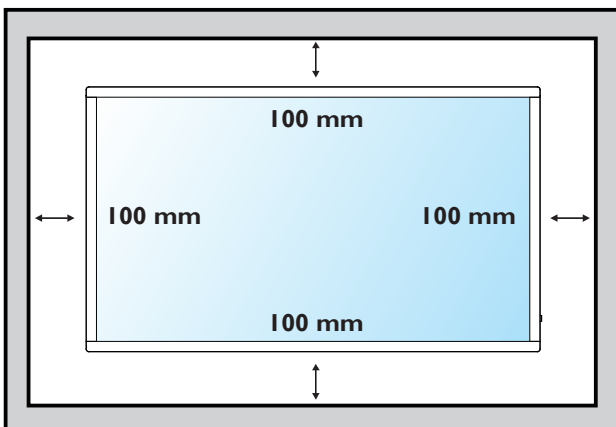

NOTE: When installing the display on a wall, please consult a professional technician for proper installation. We accept no liability for installations not performed by a professional technician.

1.6. Mounting in Portrait Position

This display can be installed in portrait position.

1. Remove the table stand, if attached.
2. Rotate 90 degrees clockwise.

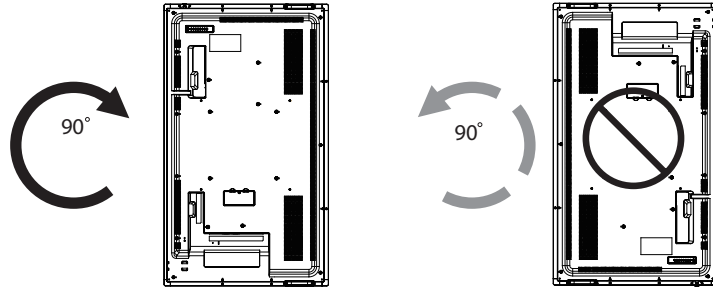

2. Parts and Functions

2.1. Control Panel

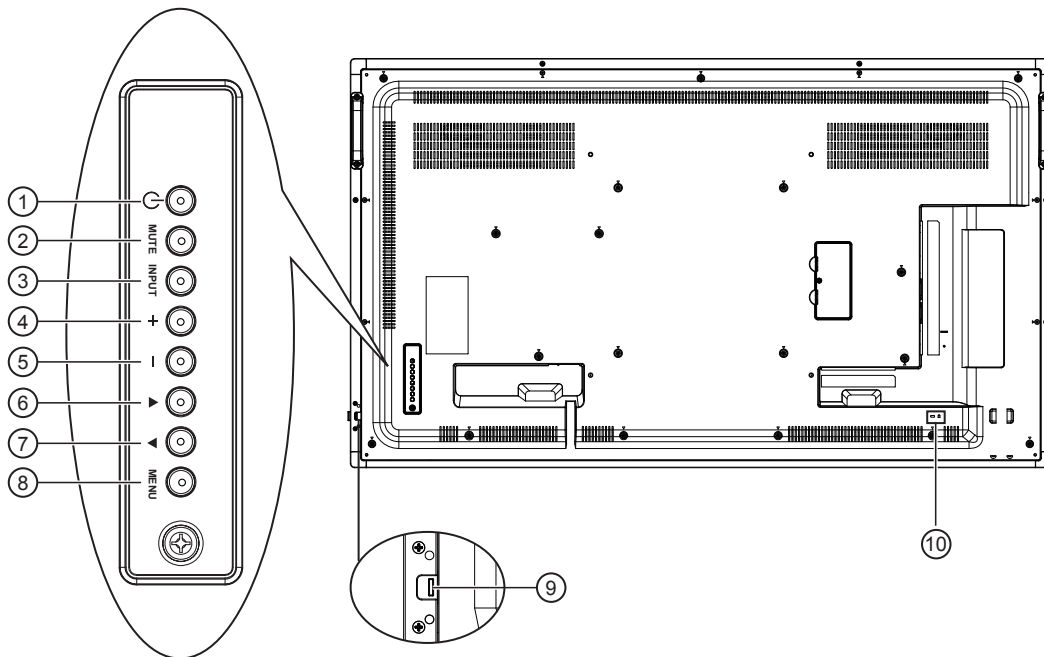

① [⏻] button

Use this button to turn the display on or put the display to standby.

② [MUTE] button

Switch the audio mute ON/OFF.

③ [INPUT] button

Press to select input source.

④ [++] button

Press to move the highlight bar right to selected item or increase the adjustment while OSD menu is on, or to increase the audio output level while OSD menu is off.

⑤ [--] button

Press to move the highlight bar left to selected item or decrease the adjustment while OSD menu is on, or to decrease the audio output level while OSD menu is off.

⑥ [▲] button

Press to move the highlight bar up while OSD menu is on.

⑦ [▼] button

Press to move the highlight bar down while OSD menu is on.

⑧ [[MENU] button

Press to access the OSD menu.

⑨ Remote control sensor and power status indicator

- Receives command signals from the remote control.
- Indicates the operating status of the display:
 - Lights green when this display is turned on
 - Lights red when this display is in standby mode or DC power off.
 - Lights amber when the display enters Sleeping mode.
 - When {**SCHEDULE**} is enabled, the light blinks green and red.
 - Lights off when the main power of the display is turned off or {**Power LED light**} turn off.
- Push up to hide the lens:

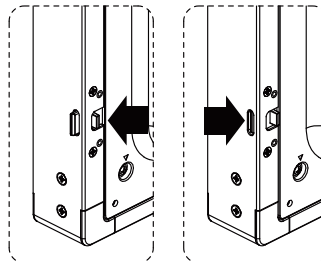

⑩ SECURITY LOCK

Used for security and theft prevention.

2.2. Input/Output Terminals

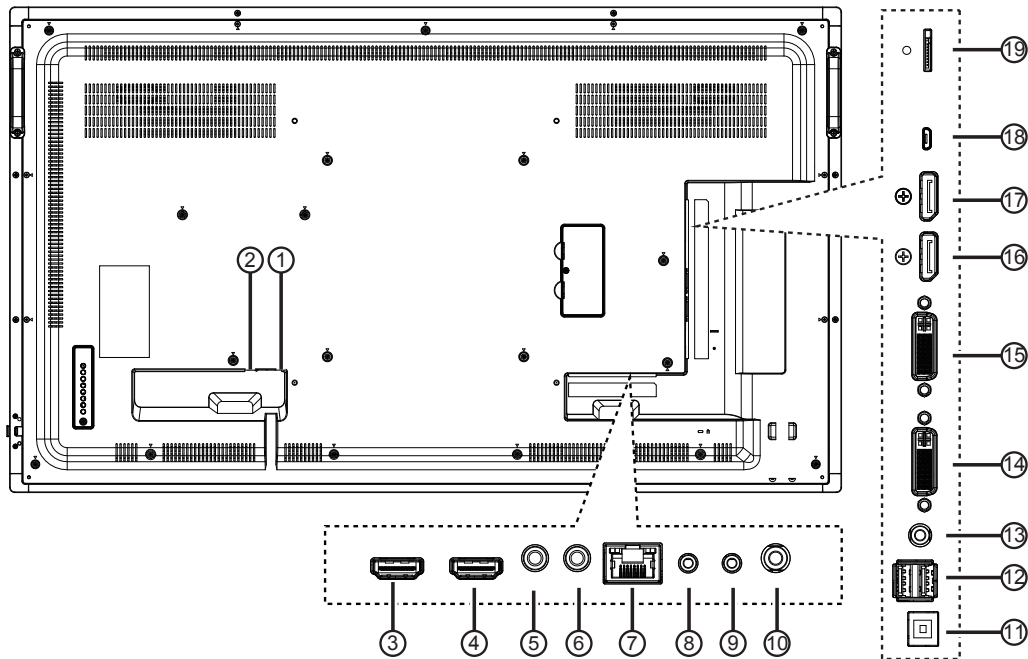

- ① **AC IN**
AC power input.
- ② **MAIN POWER SWITCH**
Main power on/off switch.
- ③ **HDMI 1 IN** / ④ **HDMI 2 IN**
HDMI video/audio input.
- ⑤ **IR IN** / ⑥ **IR OUT (3.5 mm)**
IR signal output/input for the loop-through function.
- NOTES:**
- This display's remote control sensor will stop working if the jack [IR IN] is connected.
 - To remotely control your A/V device via this display, refer to page 13 for **IR Pass Through** connection.
- ⑦ **RJ-45**
LAN control function for the use of remote control signal from control center.
- ⑧ **RS232C IN** / ⑨ **RS232C OUT (2.5 mm)**
RS232C network output/input for the loop-through function.
- ⑩ **AUDIO OUT (3.5mm)**
Audio signal output to connect your external AV device.
- ⑪ **USB-B**
Touch out.
- ⑫ **USB PORT/USB power supply (5V2A)**
Connect your USB storage device.
- ⑬ **LINE IN (3.5mm)**
Audio input from your PC.
- ⑭ **DVI IN** / ⑮ **DVI OUT**
DVI-D video input.
- ⑯ **DisplayPort IN** / ⑰ **DisplayPort OUT**
DisplayPort video input / output.
- ⑱ **MICRO USB**
Micro USB support OTG and Firmware update.
- ⑲ **MICRO SD**
Micro SD card support 32GB (Max.)

2.3. Remote Control

2.3.1. General functions

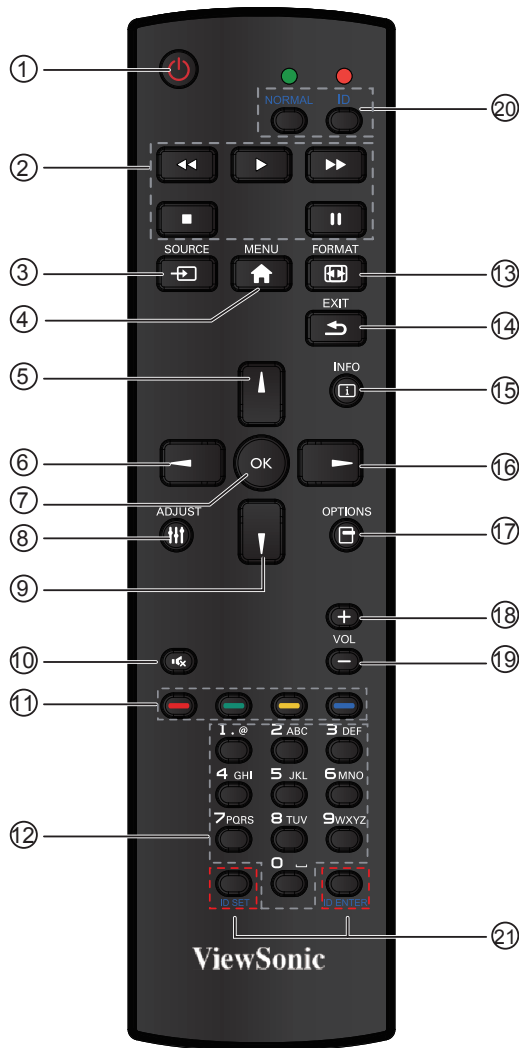

- ① **[POWER] button**
Press to switch on the display from standby mode. Press again to turn it off and back into standby mode.
- ② **[PLAY] button**
Control playback of media files (for Media Input only).
- ③ **[SOURCE] button**
Press to toggle Video Source Menu. Press [▲] or [▼] button to select one of the video sources among **Displayport, DVI-D, VGA, HDMI1, HDMI2, Media Player, Browser or PDF Player**. Press [OK] button.
- ④ **[MENU] button**
Press to turn the OSD menu on/off.
- ⑤ **[▲] button**
Press to move the selection up in OSD menu.
- ⑥ **[◀] button**
Press to decrease the value in OSD menu.
- ⑦ **[OK] button**
Press to activate the setting inside the OSD menu.
- ⑧ **[ADJUST] button**
Press to run the Auto Adjust function.

NOTE: This button is functional for VGA input only.

- ⑨ **[▼] button**
Press to move the selection down in OSD menu.
- ⑩ **[MUTE] button**
Press to turn the mute function on/off.
- ⑪ **COLOR buttons**
Choose tasks or options.(for Media Input only).
- ⑫ **[NUMERIC] buttons**
Enter text for network setting.
- ⑬ **[Format] button**
Press to switch screen aspect ratio.
- ⑭ **[EXIT] button**
Press to turn back to the previous OSD menu.
- ⑮ **[INFO] button**
Press to turn on/off the information OSD displayed on the upper right corner of the screen.
- ⑯ **[▶] button**
Press to increase the value in OSD menu.
- ⑰ **[OPTION] button**
Access currently available options, picture and sound menus (for Media Input only).
- ⑱ **[+] Volume up button**
Press to increase the audio output level.
- ⑲ **[-] Volume down button**
Press to decrease the audio output level.
- ⑳ ㉑ **[ID SET] button**
If a single large- screen matrix (video wall) is created, set ID key to control each display.

ID Remote Control:

You can set the remote control ID when you want to use this remote control on one of several different displays. Press [ID] button. The red LED blinks twice.

1. Press [ID SET] button for more than 1 second to enter the ID mode. The red LED lights up. Press the [ID SET] button again will exit the ID Mode. The red LED lights off. Press the digit number [0] ~ [9] to select the display you want to control.
For example: press [0] and [1] for display No.1, press [1] and [1] for display No. 11. The numbers available are from [01] ~[255].
2. Not pressing any button within 10 seconds will exit the ID Mode.
3. If an error pressing of buttons other than the digits occurred, wait 1 second after the red LED lights off and then lights up again, then press the correct digits again.
4. Press [ID ENTER] button to confirm. The red LED blinks twice and then lights off.

NOTE:

- Press [NORMAL] button. The green LED blinks twice, indicating the display is in normal operation. It is necessary to set up the ID number for each display before selecting its ID number.

2.3.2. Inserting batteries in the remote control

The remote control is powered by two 1.5V AAA batteries.

To install or replace batteries:

1. Press and then slide the cover to open it.
2. Align the batteries according to the (+) and (-) indications inside the battery compartment.
3. Replace the cover.

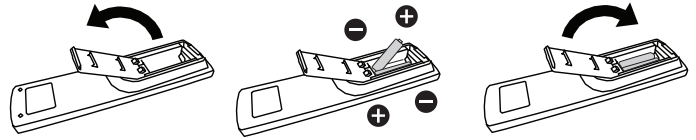

Caution:

The incorrect use of batteries can result in leaks or bursting. Be sure to follow these instructions:

- Place “AAA” batteries matching the (+) and (-) signs on each battery to the (+) and (-) signs of the battery compartment.
- Do not mix battery types.
- Do not combine new batteries with used ones. It causes shorter life or leakage of batteries.
- Remove the dead batteries immediately to prevent them from liquid leaking in the battery compartment. Don't touch exposed battery acid, as it can damage your skin.

NOTE: If you do not intend to use the remote control for a long period, remove the batteries.

2.3.3. Handling the remote control

- Do not subject to strong shock.
- Do not allow water or other liquid to splash the remote control. If the remote control gets wet, wipe it dry immediately.
- Avoid exposure to heat and steam.
- Other than to install the batteries, do not open the remote control.

2.3.4. Operating range of the remote control

Point the front of the remote control toward this display's remote control sensor when pressing a button.

Use the remote control within a distance of less than 10m/33ft from this display's sensor, and a horizontal and vertical angle of less than 30 degrees.

NOTE: The remote control may not function properly when the remote control sensor on this display is under direct sunlight or strong illumination, or when there is an obstacle in the path of signal transmission.

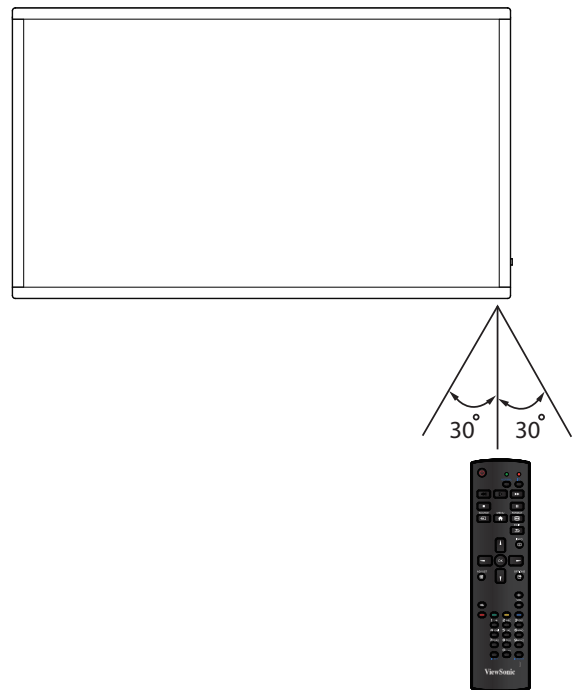

3. Connecting External Equipment

3.1. Connecting External Equipment (DVD/VCR/VCD)

3.1.1. Using HDMI video input

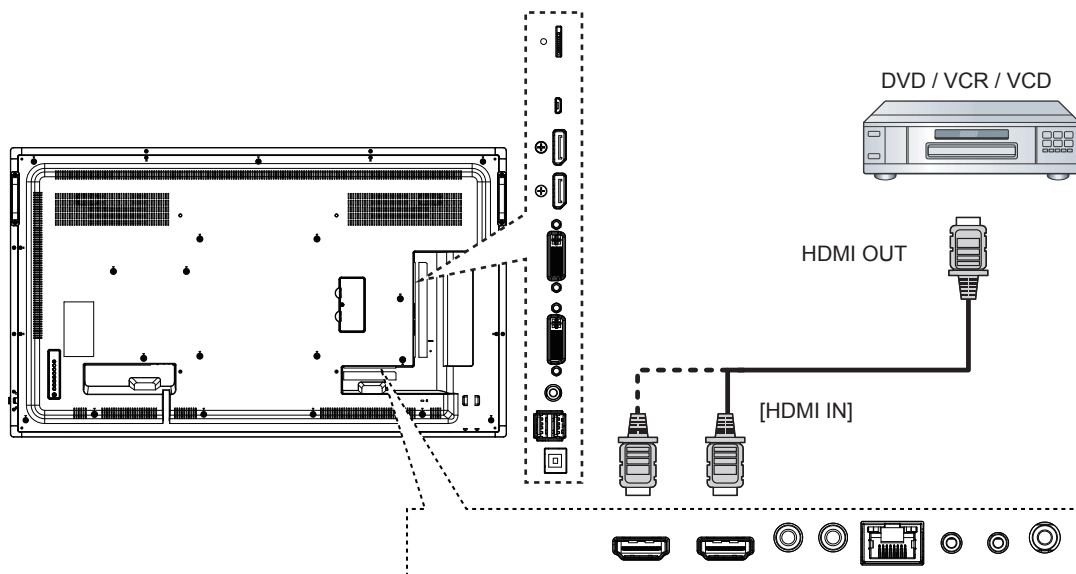

3.2. Connecting a PC

3.2.1. Using VGA input

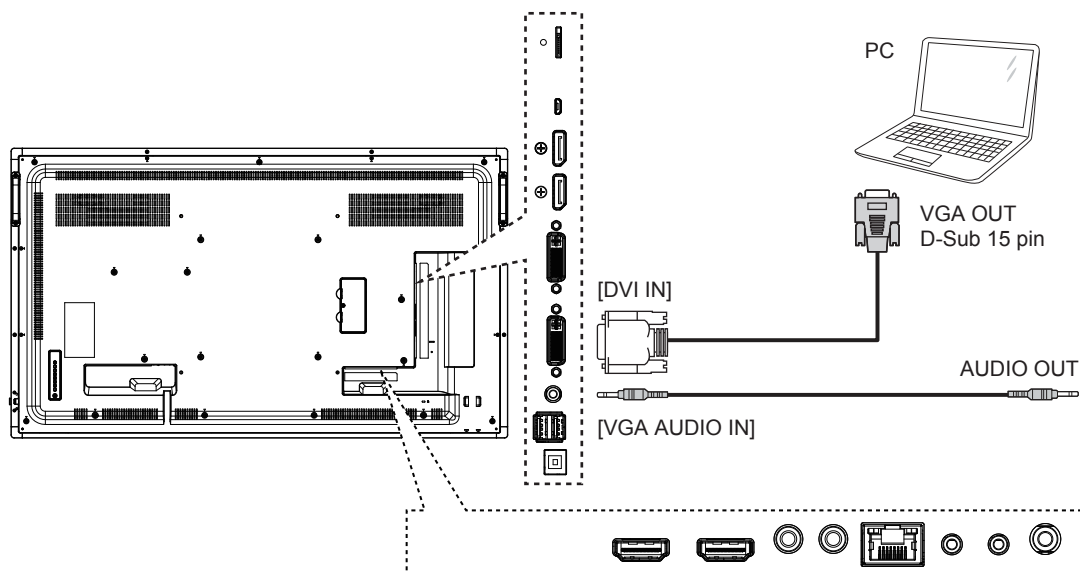

3.2.2. Using DVI input

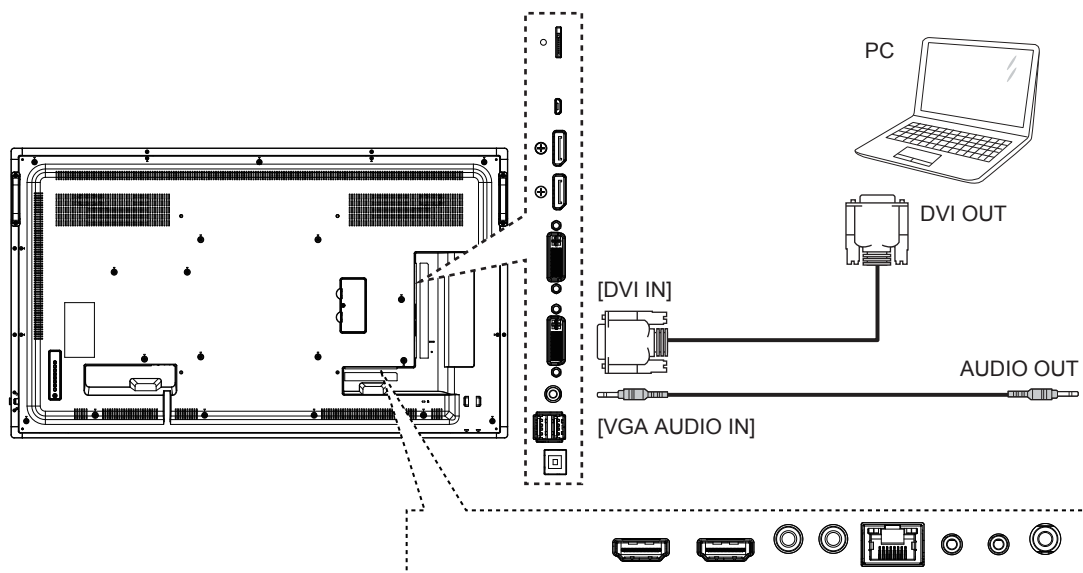

3.2.3. Using HDMI input

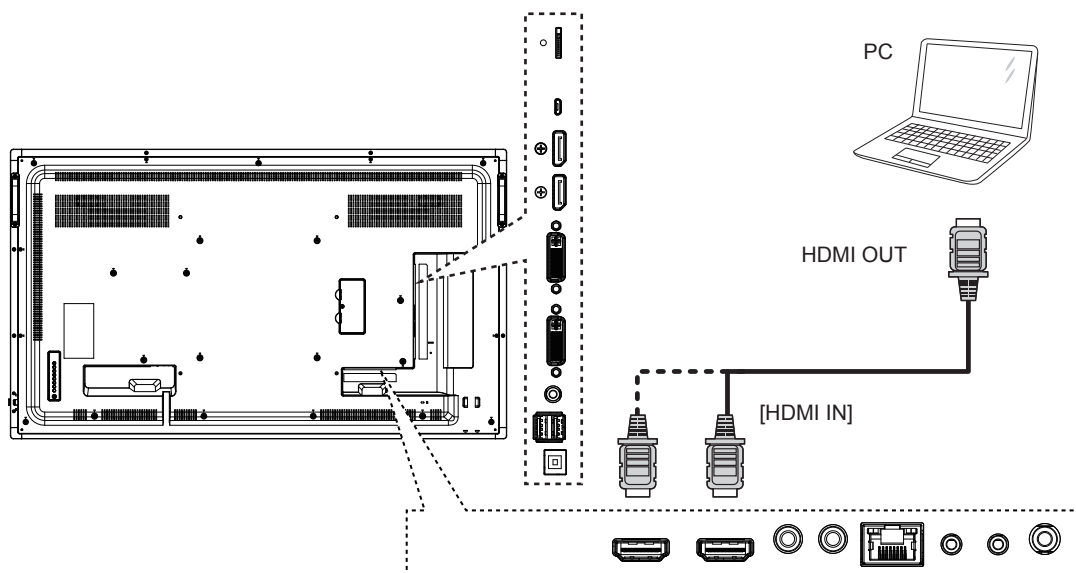

3.2.4. Using DisplayPort input

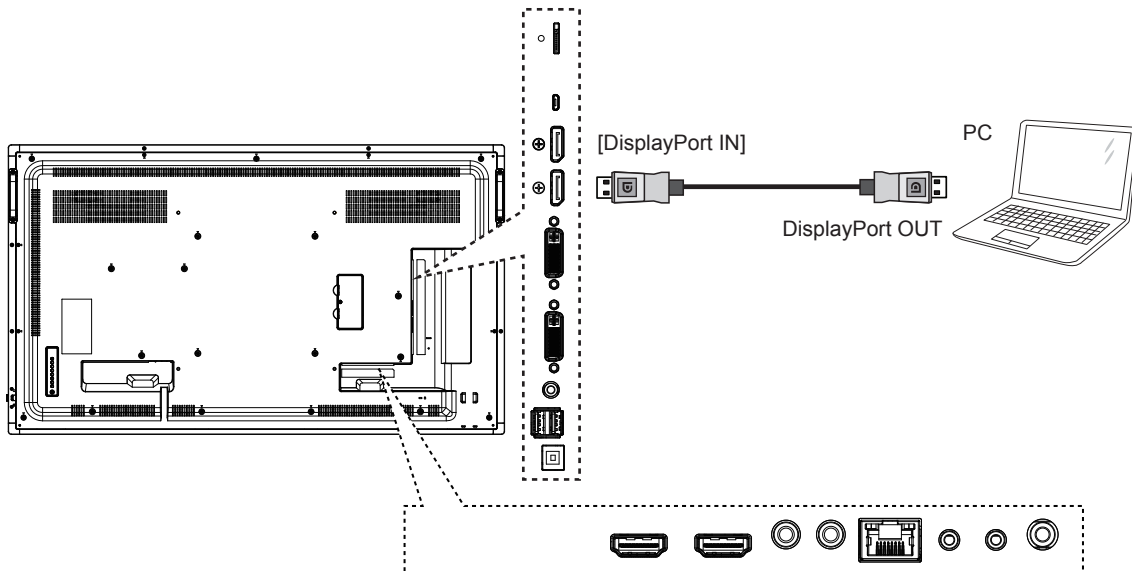

3.3. Connecting Audio Equipment

3.3.1. Connecting an external audio device

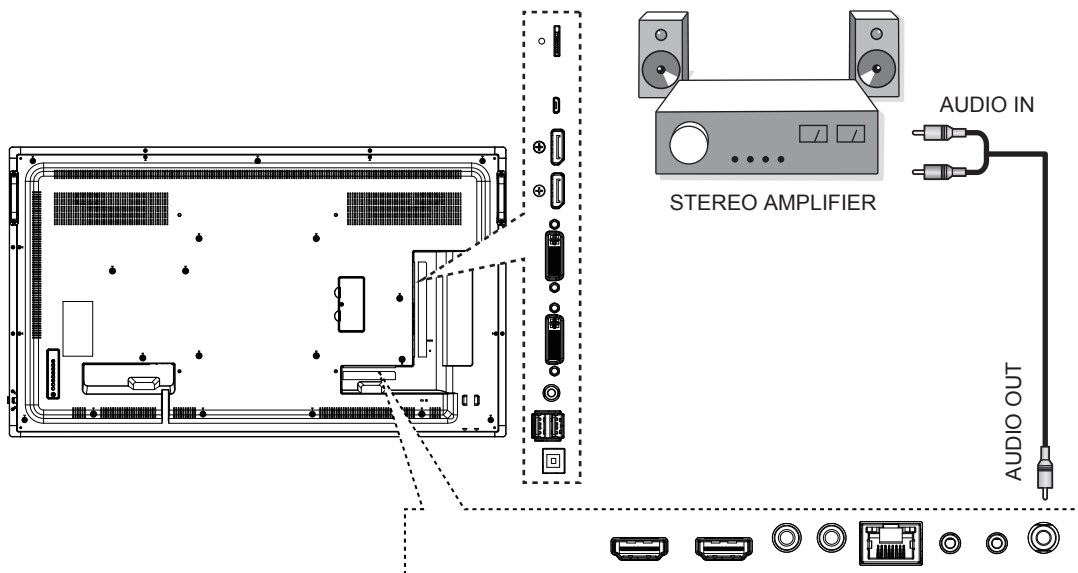

3.4. Connecting Multiple Displays in a Daisy-chain Configuration

You can interconnect multiple displays to create a daisy-chain configuration for applications such as a video wall.

3.4.1. Display control connection

Connect the [RS232C OUT] connector of DISPLAY 1 to the [RS232C IN] connector of DISPLAY 2.

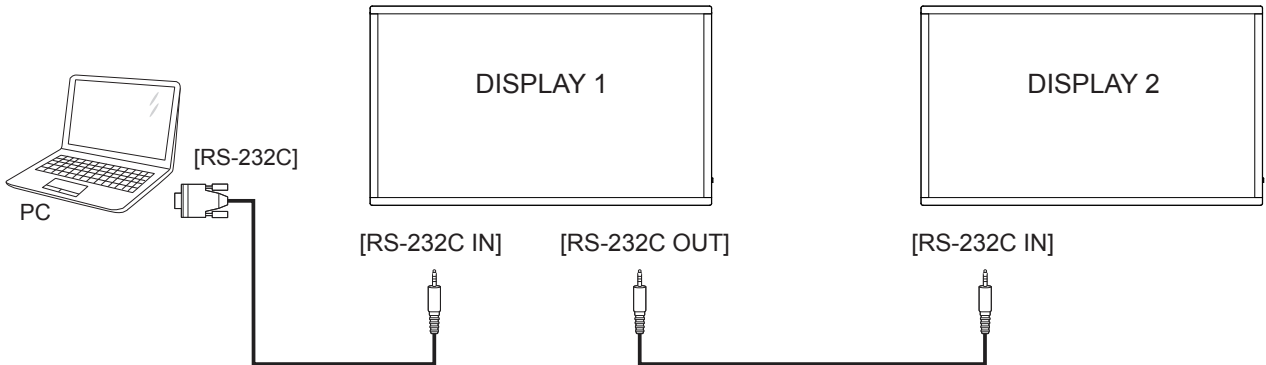

3.4.2. Digital video connection

Connect the [DVI OUT] connector of DISPLAY 1 to the [DVI IN] connector of DISPLAY 2.

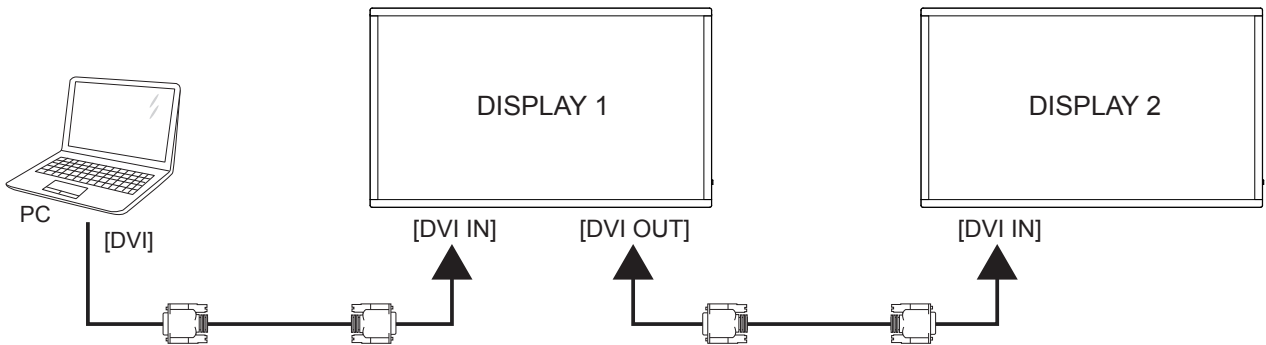

Connect the [DP OUT] connector of DISPLAY 1 to the [DP IN] connector of DISPLAY 2.

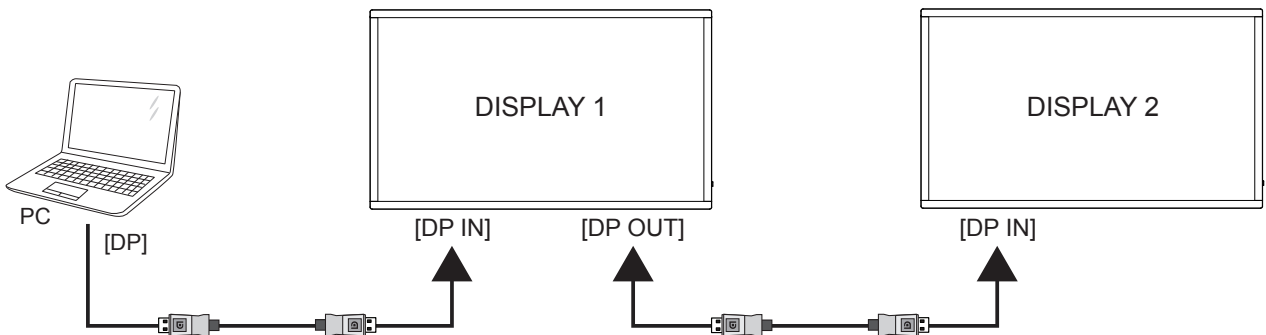

3.5. IR connection

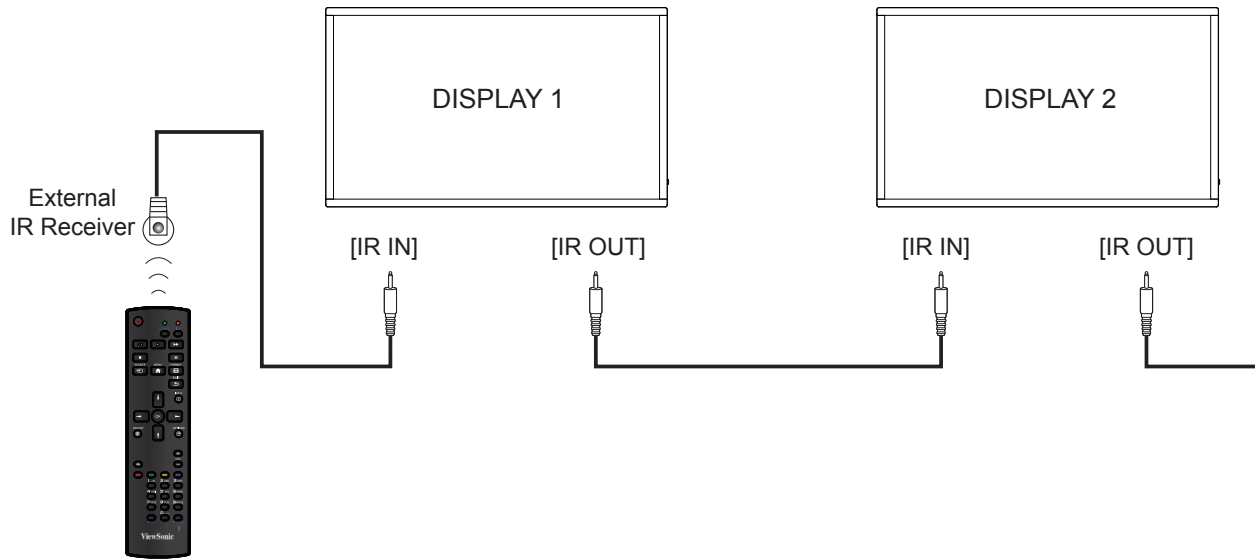

NOTE: This display's remote control sensor will stop working if the [IR IN] is connected.

3.6. IR Pass-through Connection

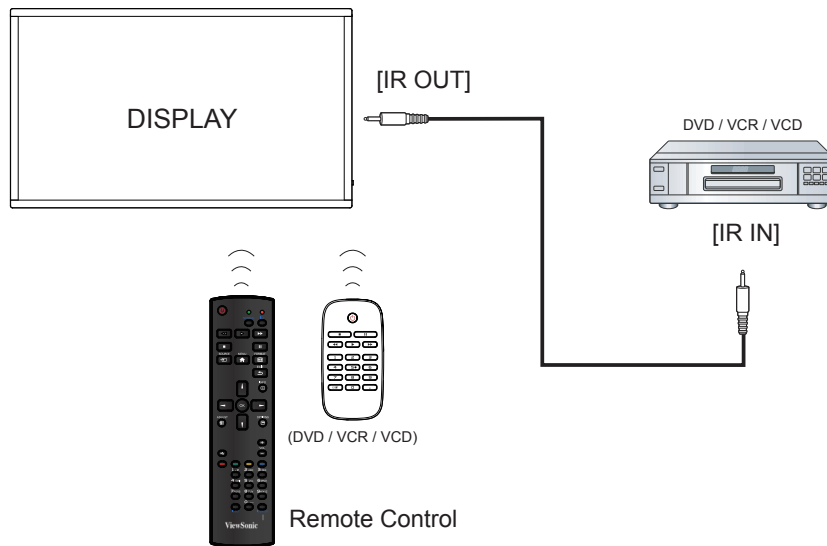

4. Operation

NOTE: The control button described in this section is mainly on the remote control unless specified otherwise.

4.1. Watch the Connected Video Source

See page 8 for external equipments connection.

1. Press **SOURCE** button .
2. Press **▲** or **▼** button to select a device, then press **OK** button.

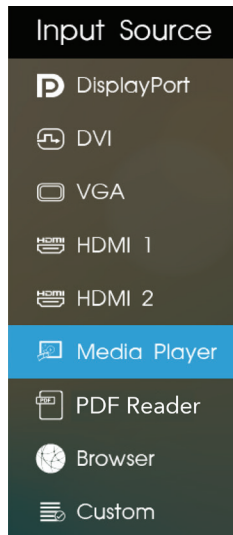

4.2. Change Picture Format

You can change the picture format to suit the video source. Each video source has its available picture formats.

The available picture formats depend on the video source:

Press **FORMAT** button to change the picture format.

- **{FULL}**: Enlarge the picture to fill the screen.
- **{NORMAL}**: 4:3 format.
- **{DYNAMIC}**: 16:9 format.
- **{REAL}**: This mode displays the image pixel-by-pixel on screen without scaling the original image size.
- **{21:9}**: 21:9 format.
- **{CUSTOM}**: Custom define.

4.3. Media Player

You can publish videos, photos, music and widget to play from Signage Manager Software.

4.3.1. Base settings in Display

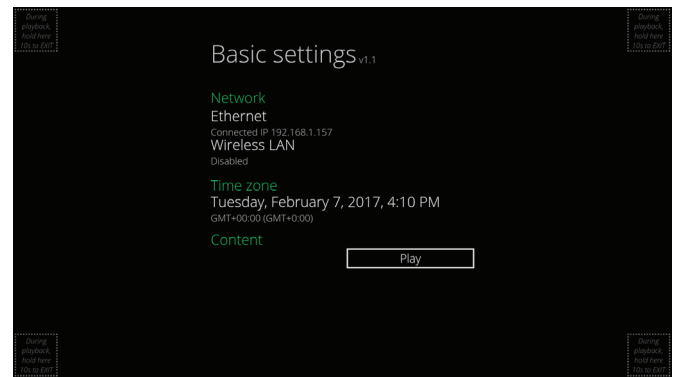

Ethernet: To turn Ethernet On or Off.

Wireless LAN : To turn Wireless LAN On or Off.

Time Zone: User can set up Time Zone manually.

4.3.2. Signage Manager

You can create content playlist from Signage Manager and publish to display.

NOTE: Please download Signage Manager from <http://vsweb.us/signagemanager> and install on your PC.

1. Press **{Create playlist}** button

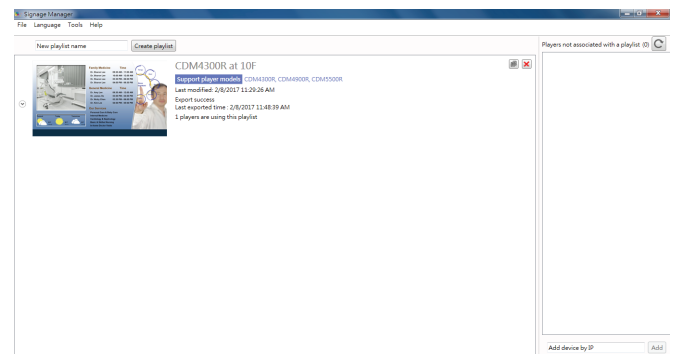

2. Select player model

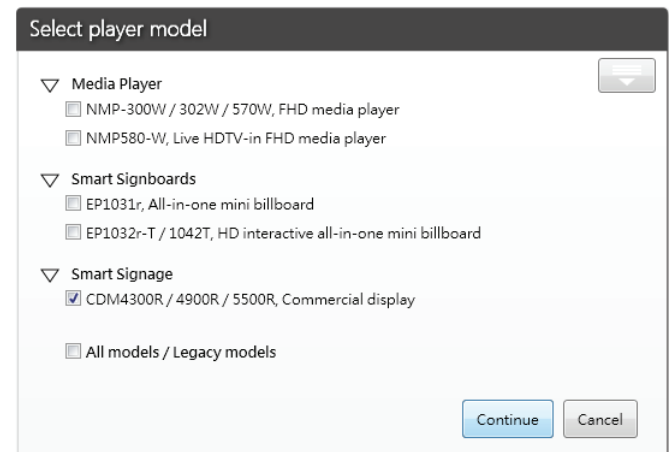

3. Select Orientation, Empty templates and Pre-designed templates and press ➡ to next step.

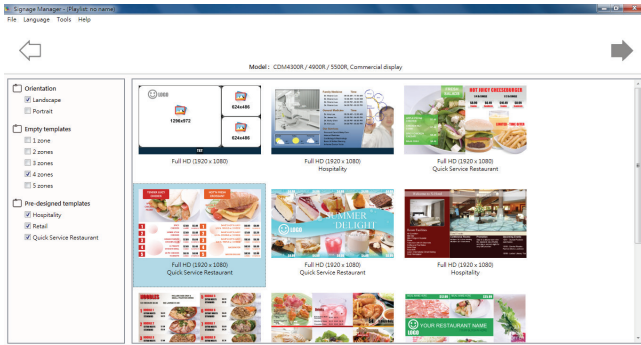

4. Press {Edit schedule} button to add schedule

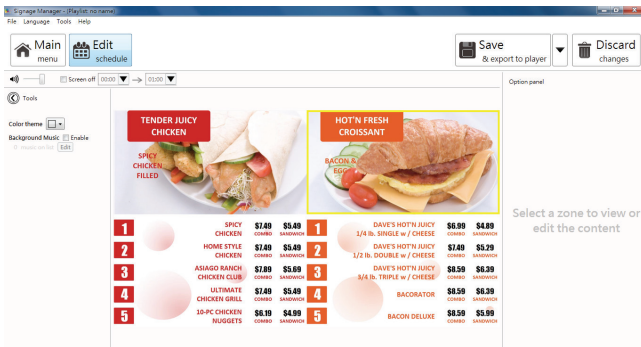

5. Press {Add schedule} button to set playlist schedule

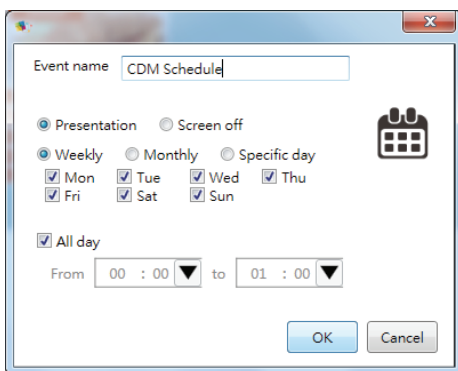
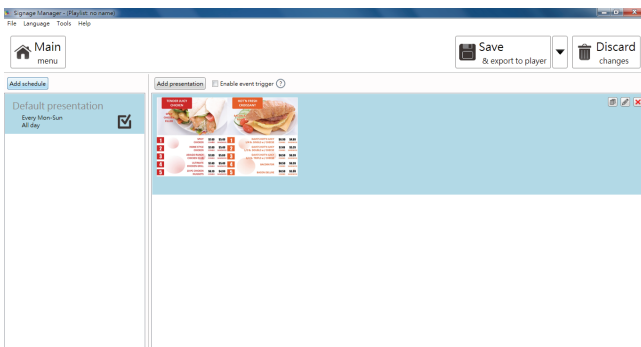

6. And then you can export to player or USB

• Export to Player (Display)

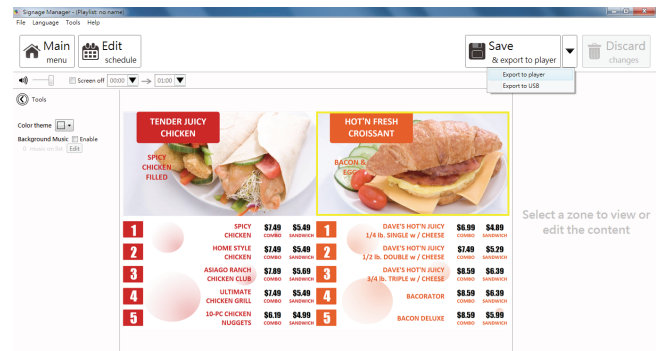

• Select player and press OK

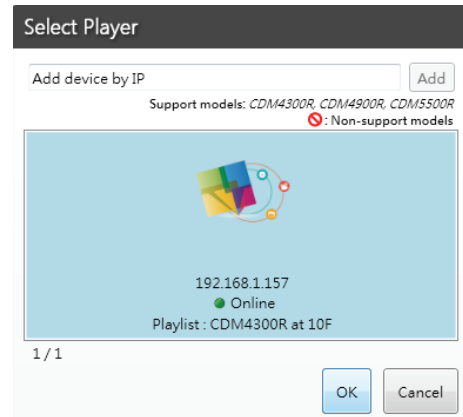

• It will show player status.

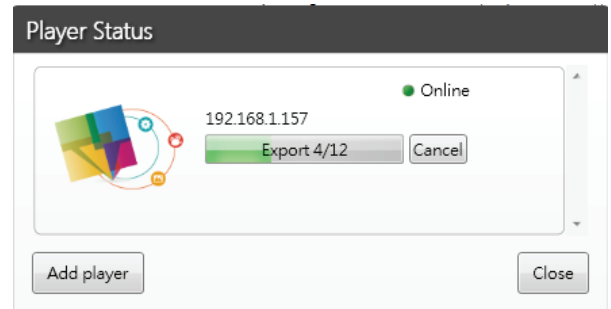

• Export to USB

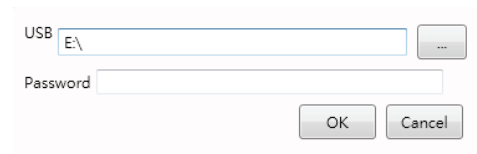

4.4. Web Browser

You can save the web link and easy to browse the web site.

Browser page has one item: {Settings}. Press {Settings} then enter next page.

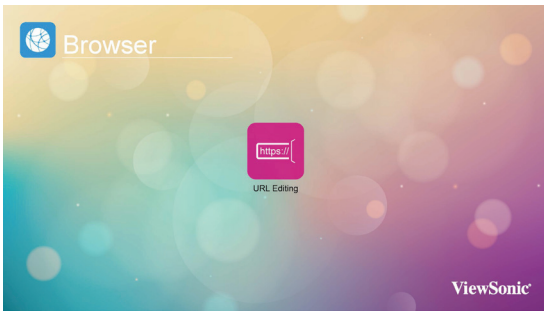

1. Users can choose 1~7. Press any one will show a dialog.

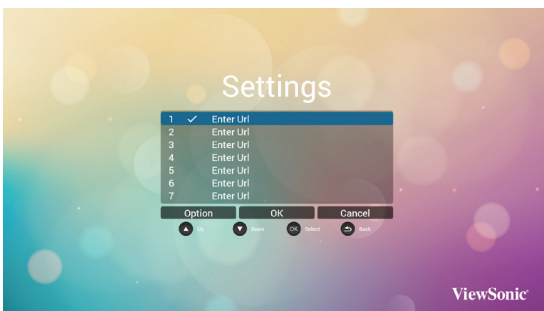

Enter URL and press OK then data will save on List

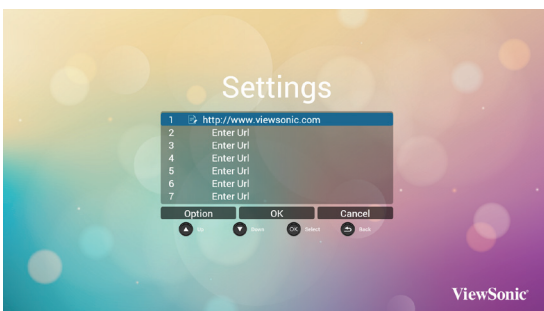
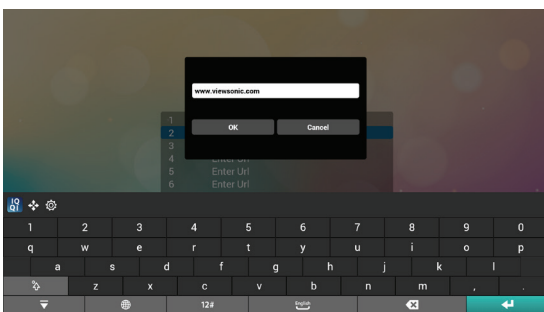

- 2. Press "Option" then left side will pop up a list
- Import : Import url list file
- Export : Export url list file
- Delete all : Delete all url record on right side
- Back : left side list will be close.

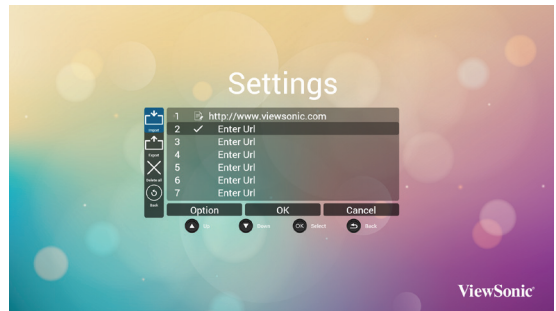

A. Import
Click Import, you can select URL file from Internal, USB storage or SD card.

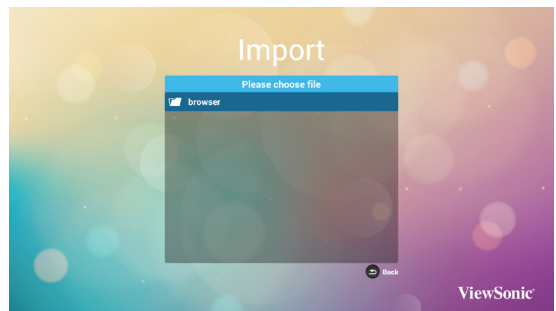

After URL file selected, URL will show on list.

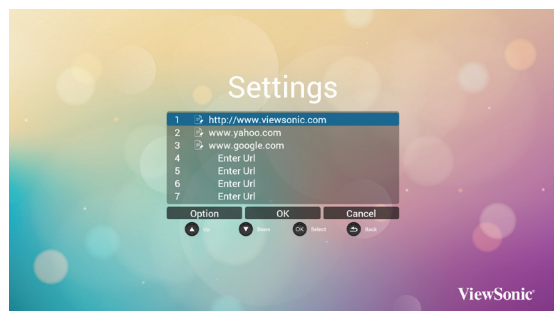

B. Export



Click Export, you can select Internal, USB storage or SD card for export file to.



Dialog shows path file will be saved and file's name. Press "save" button then URLs on list will be saved.

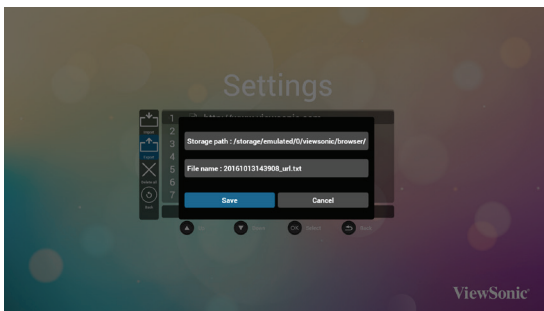

3. On URL list page, if you select non-empty item, it will show a dialog to ask edit or play url. If press "Edit", it will show edit url dialog, if press "Play", it will show web page of item's url.

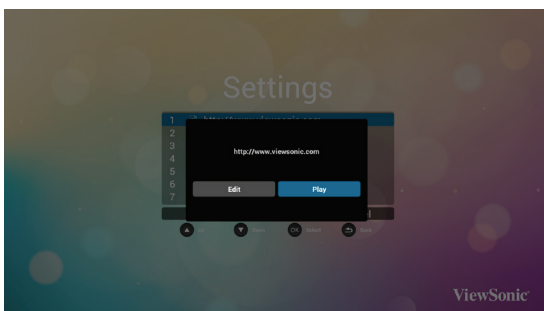

4.5. PDF Reader

You can play PDF file on your display from internal, USB or SD card.

This page has three items: **{Play}**, **{Compose}** and **{Settings}**.

- **{Play}** : select playlist to play.
- **{Compose}**: edit playlist.
- **{Settings}**: setting play properties.

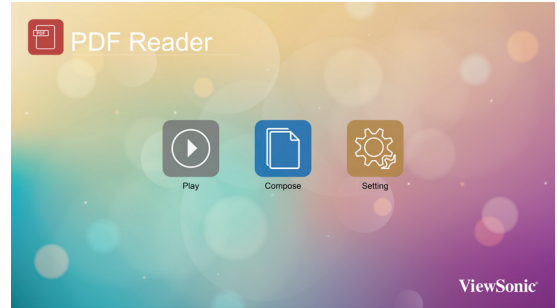

1. Select **{Play}** on this page, first you should choose one playlist to play between FILE 1 and FILE 7. The pencil icon means the playlist is non-empty.

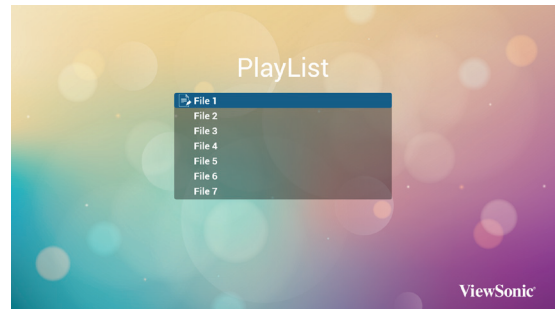

2. Select **{Compose}** on this page, first you should choose one playlist to edit between FILE 1 and FILE 7. The pencil icon means the playlist is non-empty.

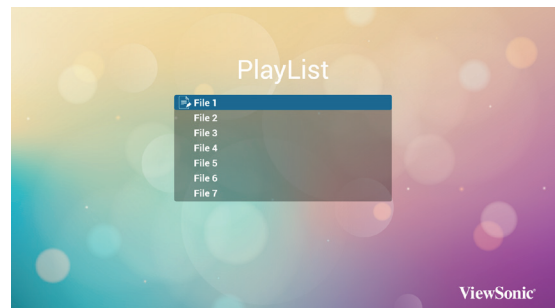

- A. If an empty playlist is chosen, the app will guide you to select the media source. All media files should be placed in /viewsonic/ of root directory. For example,

- pdfs in /root/viewsonic/pdf/

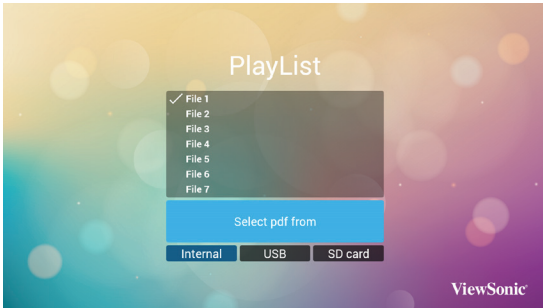

- B. You could edit or delete a non-empty playlist, just choose the desired playlist which is with pencil icon.

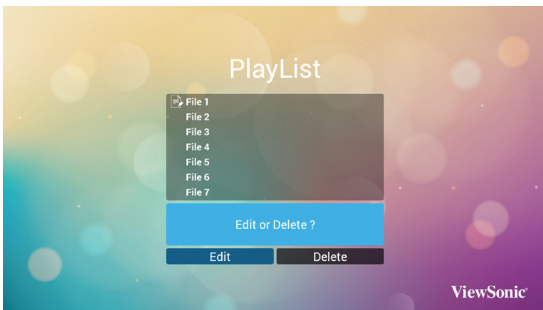

- C. Once you start to edit a playlist, you will see below screen. Source - files in storage. Playlist – files in playlist. There are 4 icons which map to the keys of remote controller. Option key – launch sidebar. Play key – play media file. Info key – show media info. Ok key – select/unselect file.

In the sidebar, it helps you to do the following:

- select all : select all storage files.
- delete all : delete all playlist files.
- add/remove : update playlist from source.
- sort : sort playlist.
- save/abort : save or abort playlist.
- back : return.

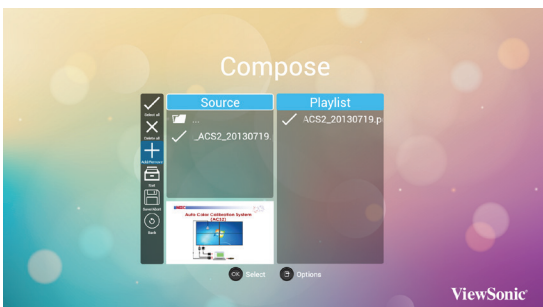

Select "Sort" in the sidebar, you can change the order of files one by one.



3. Select {Settings} on this page, this page has two parts, {Repeat Mode} and {Effect Duration}.

- {Repeat Mode} : play mode.
- {Effect Duration} : photo effect duration.



4.6. Custom

Select custom app from source setting.

1. Entry Signage Display in Admin Mode (Refer section 4.7 & 4.7.3)

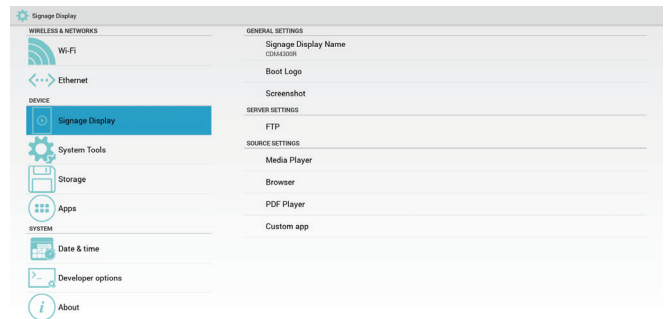

2. Select **Custom app** will show the installed APK. CDM model pre-install the Enplug APK inside.

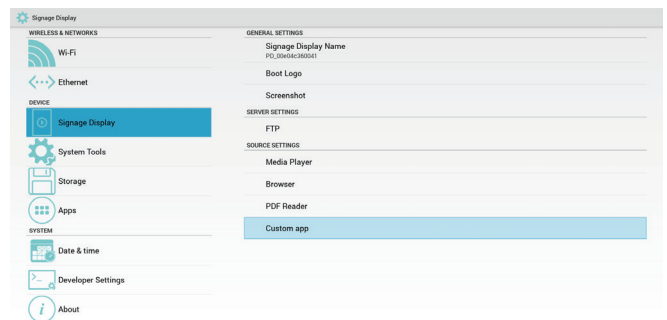

3. Press Select App to show the APK list.

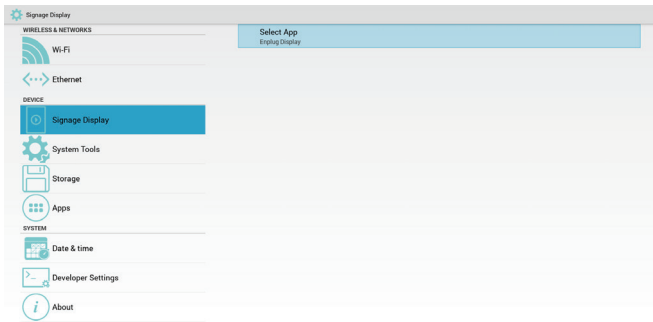

4. Select Enplug Display and press Save.

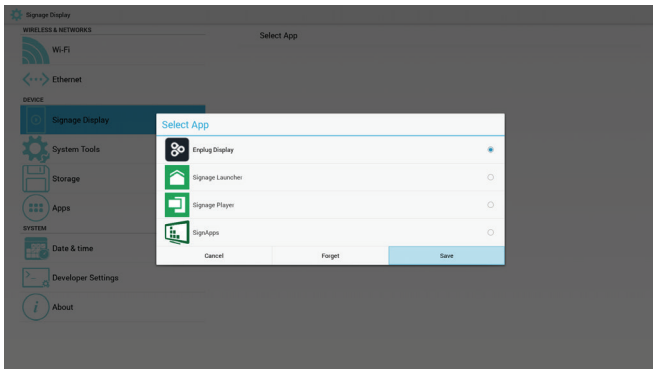

5. Enplug Display APK name will show on Select App.

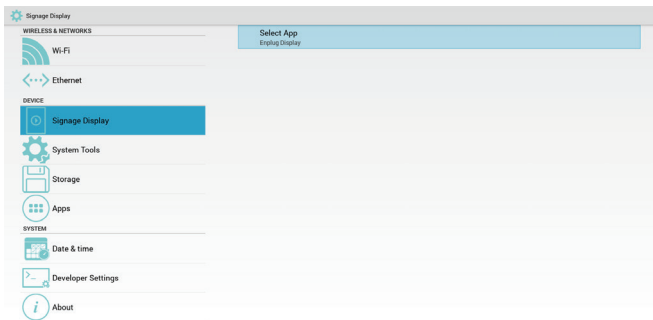

6. Exit admin mode and press custom input source. Enplug Display will run on screen.

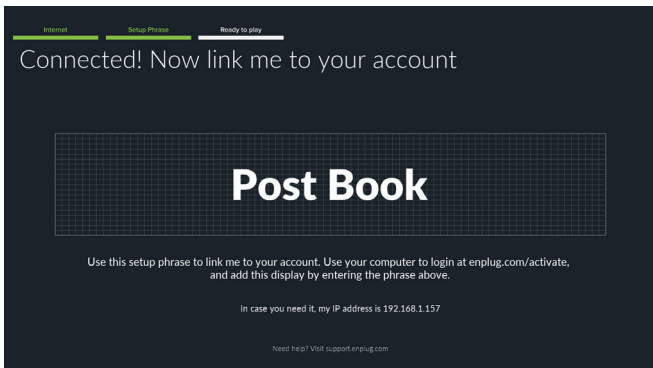

4.7. Setting (Admin mode)

Press Menu 1 9 9 8 on remote control to enter admin mode.



4.7.1. Wi-Fi

Via Enable/Disable to control Wi-Fi On/Off. After Enable, the screen will list all available WiFi AP.
Note: Ethernet will be disabled automatically if WiFi turn on and connect to network.

4.7.2. Ethernet

Enable: To turn Ethernet On.
Disable: To turn Ethernet Off
Enable Ethernet will show Connection Type and Mac Address.

- Connection Type: Available type is DHCP/Static IP
 - DHCP
 - Static IP
 - IP Address
 - Netmask
 - DNS Address
 - Gateway Address
- Mac Address
Note: WiFi will be disabled automatically if Ethernet turn on and connect to network.

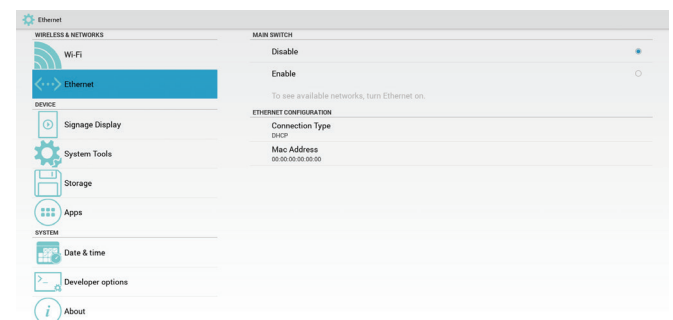

4.7.3. Signage Display

There are 3 groups: General Settings / Server Settings / Source Settings.

1. General Settings

- Signage Display Name: Set the PD name, default name is "PD" + Ethernet Mac Address. The name is up to 36 characters.
- Boot Logo: Scalar OSD menu to control Android boot logo enable/disable.
- Screenshot: Via Enable/Disable to control screenshot On/Off. After Enable, user can set screenshot timeslot and save path.

Note: Time slot of deletion and screenshot:

- (1) Will delete picture at initial time 0 sec.
- (2) Will screenshot at first 40 sec.

2. Server Settings

- FTP: Via Enable/Disable to control FTP On/Off. After setup, PD can share FTP files.

3. Source Settings

- Browser: Open Browser setting page.
- PDF Reader: Open Play List and effect setting page in PDF Player.
- Custom app: Let user select custom app.

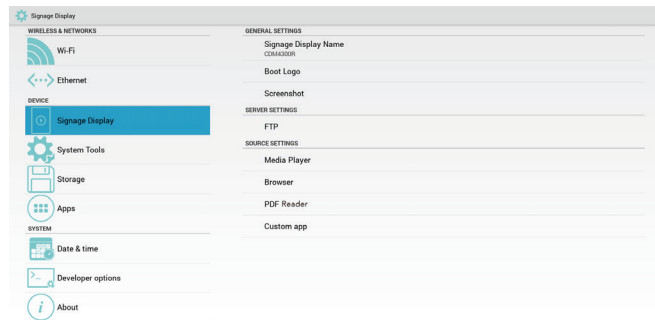

4.7.4. System Tools

There are 3 functions:

1. Clear Storage: Clear all data in viewsonic folder.
2. Factory Reset: Reset all settings.
3. Import & Export: Import/Export PD settings.

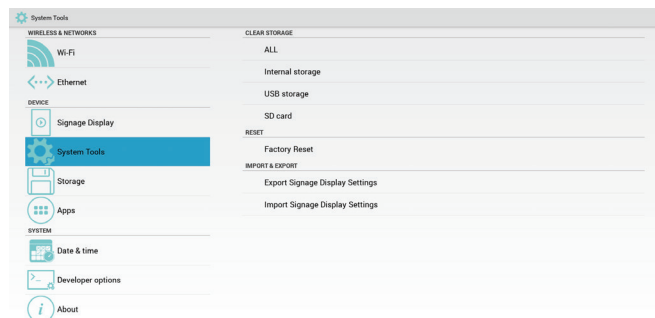

4.7.5. Storage

Show the storage space information.

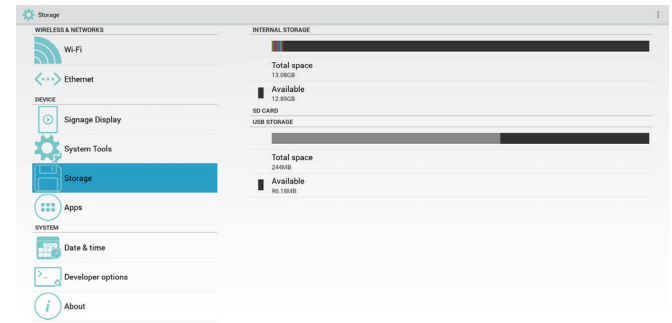

SD CARD and USB STORAGE

Need to insert SD card or USB, the information will show up total space and available of SD card or USB storage.

4.7.6. Apps

Show the App information.

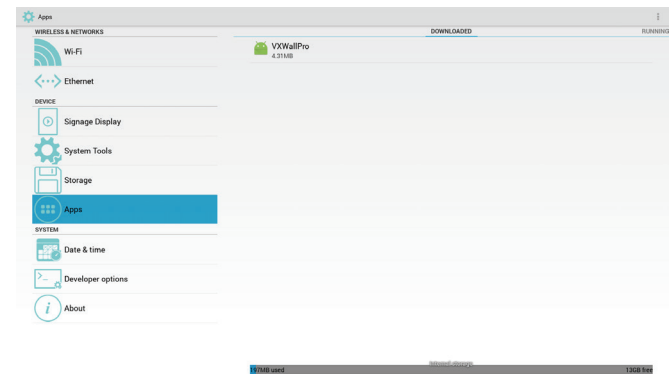

4.7.7. Date & Time

Via Scalar OSD menu to control Auto Time On/Off. When Salar OSD menu turn off Auto time, user can set up Time Zone manually.

Note: Add new NTP server to display current serverIP.

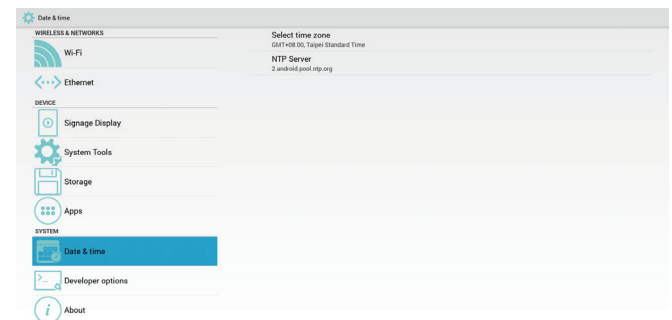

4.7.8. Development Setting

The options are for Android development.

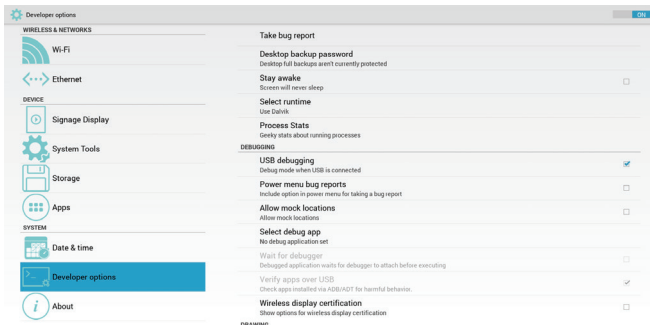

4.7.9. About

This page will show

1. System updates
Will automatically search update.zip in USB or SD card.
Will be shown in list for user selection if found
Note:
(1) Only support Android Full image.
(2) File name should be update.zip
(3) The file should be located in root of storage.
2. Android version
3. Kernel version
4. Build number

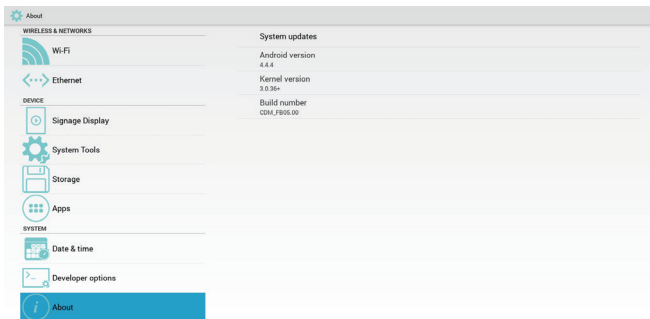

5. OSD Menu

An overall view of the On-Screen Display (OSD) structure is shown below. You can use it as a reference for further adjusting your display.



Navigating the OSD menu using the remote control:

1. Press the [HOME] **MENU** button to display the OSD menu.
2. Press [UP] [DOWN] [LEFT] or [RIGHT] button to select its menu item or to adjust its value. Press **OK** button to confirm.
3. Press [BACK] **EXIT** button to go back to the previous menu layer.
4. Press [HOME] **MENU** button to exit the OSD menu.

Navigating the OSD menu using the display's control buttons:

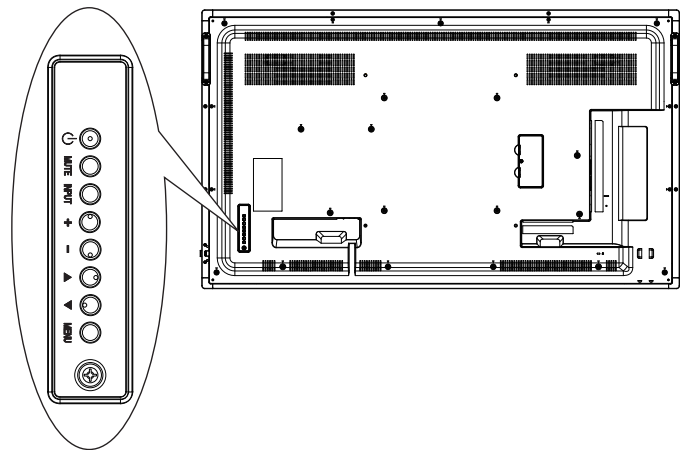

1. Press the **MENU** button to display the OSD menu.
2. Press the [UP] [DOWN] [+] or [-] to select menu item or adjust its value.
3. Press [**INPUT**] button to confirm menu selection and enter its submenu.
4. Press **MENU** to confirm menu selection and enter its submenu.

5.1. Settings

5.1.1. Picture menu

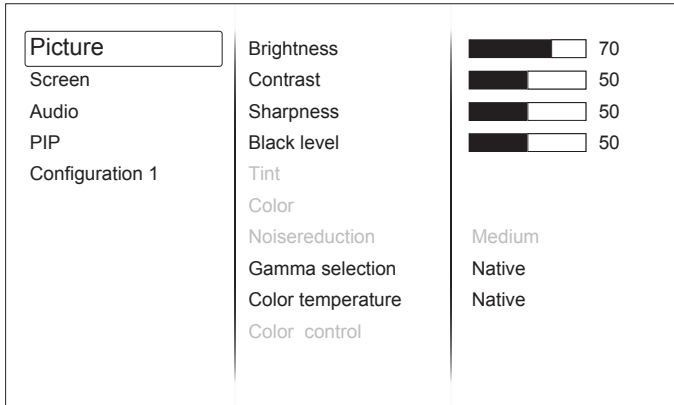

Brightness

Adjust the overall image and background screen brightness.

Contrast

Adjust the image contrast ratio for the input signal.

Sharpness

Adjust the sharpness of the picture.

Black level

Adjust the image brightness for the background.

NOTE: sRGB picture mode is standard and cannot be changed.

Tint

Adjust the tint of the screen.

NOTE: VIDEO mode only.

Color

Adjust the color of the screen.

NOTE: VIDEO mode only

Noise reduction

Adjust the noise reduction level.

Gamma Selection

Select a display gamma.

NOTE: sRGB picture mode is standard and cannot be changed.

Color Temperature

adjust the color temperature.

Color Control

The color levels of red, green, and blue are adjusted by the color bars.

R: Red gain, G: Green gain, B: Blue gain

Picture Mode

PC mode: {Standard} / {Highbright} / {sRGB}.

Video mode: {Standard} / {Highbright} / {Cinema}.

Overscan

Change the display area of the image.

ON: Set to display area about 95%

OFF: Set to display area about 100%

Blue light filter

User can adjust the value from 100 to 0 when the Color temperature value > 5000° K

Flicker free

ON: Set to Backlight to Maximun and diable Brightness adjustment

OFF: Turn off this function and set Backlight value as brightness value.

Picture Reset

Reset all settings in the Picture menu.

5.1.2. Screen menu

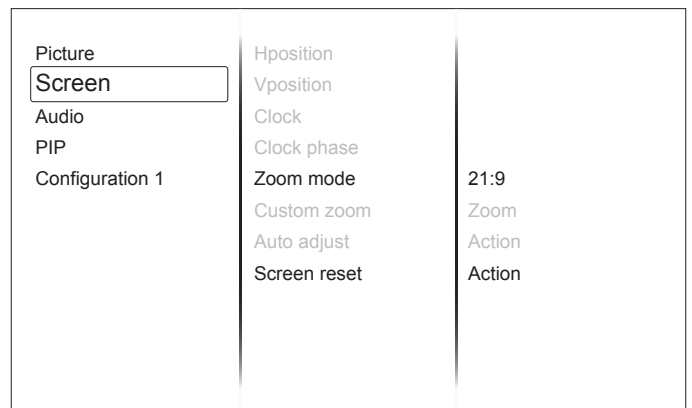

H Position

Control Horizontal Image position within the display area of the LCD.

V Position

Control Vertical Image position within the display area of the LCD.

Clock

Adjust to expand or narrow the width of the image on the screen.

NOTE: VGA input only

Clock Phase

Improves focus, clarity and image stability by increasing or decreasing this setting.

NOTE: VGA input only

Zoom Mode

PC mode: {Full} / {Normal} / {Real} / {Dynamic} / {21:9} / {Custom}.

Video mode: {Full} / {Normal} / {Real} / {Dynamic} / {21:9} / {Custom}.

NOTE: Zoom mode setting is by input. If input in multi-windows, the setting will apply for windows with the same input. And the INFO OSD will show the latest setting.

	<p>Full This mode restores the correct proportions of pictures transmitted in 16:9 using the full screen display.</p>
	<p>Normal The picture is reproduced in 4:3 format and a black band is displayed on either side of the picture.</p>
	<p>Real This mode displays the image pixel-by-pixel on screen without scaling the original image size.</p>
	<p>Dynamic The picture is reproduced in 16:9 format and a black band at the top and bottom.</p>
	<p>21:9 The picture is reproduced in 21:9 format and a black band at the top and bottom.</p>
	<p>Custom Choose to apply the custom zoom settings in the Custom Zoom submenu.</p>

Custom Zoom

You can use this function to further customize the zoom settings to suit the image you want to display.

NOTE: This item is functional only when the Zoom mode setting is set to Custom.

	<p>Zoom Expands the horizontal and vertical sizes of the image simultaneously.</p>
	<p>H zoom Expands the horizontal size of the image only.</p>
	<p>V zoom Expands the vertical size of the image only.</p>
	<p>H position Moves the horizontal position of the image left or right. The adjustable step by Zoom and H zoom setting.</p>
	<p>V position Moves the vertical position of the image up or down. The adjustable step by Zoom and V zoom setting.</p>

Auto Adjust

Press "Set" to detect and adjust H position, V position, Clock, Phase automatically.

Screen Reset

Reset all settings in the Screen menu to factory preset values.

5.1.3. Audio menu

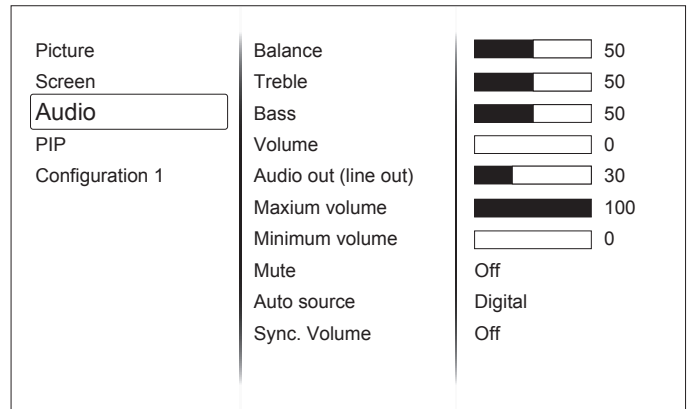

Balance

Adjust to emphasize left or right audio output balance.

Treble

Adjust to increase or decrease higher-pitched sounds.

Bass

Adjust to increase or decrease lower-pitched sounds.

Volume

Adjust to increase or decrease the audio output level.

Note: Minimum volume ≤ Volume ≤ Maximum volume

Audio Out (Line Out)

Adjust to increase or decrease line out output level.

Maximum volume

Limitation for the maximum volume setting.

Minimum volume

Limitation for the minimum volume setting.

Mute

Turn the mute function on/off.

Audio source

Select the audio input source.

Analog: audio from audio input

Digital : audio from HDMI/DVI audio.

Displayport: audio from DP.

Sync. Volume

Enable/disable audio out (line out) volume adjustability.

Audio reset

Reset all settings in the Audio menu to factory preset values.

5.1.4. PIP menu

Picture	Sub mode	Off
Screen	PIP size	Small
Audio	PIP position	Bottom-Right
PIP	PIP change	Action
Configuration 1	PIP source	VGA
	PIP audio	Main
	PIP reset	Action

Sub mode

Select the PIP (Picture-in-Picture) mode.

Choose from: **{Off}**/**{PIP}**/**{POP}**/**{Quick swap}**/**{PBP}**.

PIP size

Select the size of the sub picture in the PIP (Picture-in-Picture) mode.

Choose from: **{Small}** / **{Medium}** / **{Large}**.

PIP position

Select the position of the sub picture in the PIP (Picture-in-Picture) mode.

{Bottom-Right} / **{Bottom-Left}** / **{Top-Right}** / **{Top-Left}**

PIP change

Exchange Main and PIP/POP/PBP/Quick swap input signal.

PIP Source

Select the input signal for the sub picture.

PIP audio

Select the audio source in the Sub mode.

- **{Main}** - Select audio from the main picture
- **{Sub}** - Select audio from the sub picture.

PIP reset

Reset all settings in the PIP menu to factory preset values.

NOTES:

- The PIP function is available only for certain signal source combinations as shown in the table below.
- The availability of the PIP function will also depend on the resolution of the input signal being used.

	HDMI1	HDMI2	DVI	DisplayPort	VGA	MediaPlayer	Browser	PDF Player	Custom
HDMI1	O	X	X	O	O	X	X	X	X
HDMI2	X	O	X	O	O	X	X	X	X
DVI	X	X	O	O	X	X	X	X	X
DisplayPort	O	O	O	O	O	O	O	O	O
VGA	O	O	X	O	O	O	O	O	O
Media Player	X	X	X	O	O	O	X	X	X
Browser	X	X	X	O	O	X	O	X	X
PDF Player	X	X	X	O	O	X	X	O	X
Custom	X	X	X	O	O	X	X	X	O

(O: PIP function available, X: PIP function unavailable)

5.1.5. Config1 menu

Picture	Switch on state	Last status
Screen	Panel saving	Action
Audio	RS232 routing	RS232
PIP	Boot on source	Action
Configuration 1	WOL	Off
	Power LED light	On
	Network	On
	Configuration1 reset	Action
	Factory reset	Action

Switch on state

Select the display status used for the next time you connect the power cord.

- **{Power off}** - The display will remain off when the power cord is connected to a wall outlet.
- **{Forced on}** - The display will turn on when the power cord is connected to a wall outlet.
- **{Last status}** - The display will return to the previous power status (on/off/standby) when removing and replacing the power cord.

Panel saving

Choose to enable the panel saving functions and thus reduce the risk of "image persistence" or "ghost-imaging".

- **{Brightness}** - Select **{On}** and the image brightness will be reduced to an appropriate level. The Brightness setting in the Picture menu will be unavailable when selected.
- **{Pixel shift}** - Select the time interval (**{Auto}** / **{10 ~ 900}** Seconds/ **{Off}**) for the display to slightly expand the image size and shift the position of pixels in four directions (up, down, left, or right). Activating Pixel Shift will disable H Position, V Position and Zoom Mode in the Screen Menu.

RS232 Routing

Select the network control port.

Choose from: **{RS232}** / **{LAN->RS232}**.

Boot on Source

Choose to select source when boot up.

Input: select input source when bootup.

Playlist: select playlist index for Media player, Browser, PDF player.

0: no play list. Same as switch source from OSD.1~7: playlist number.

WOL

Choose to turn on or off the wake on LAN function.

Choose from : {Off} / {On}

NOTE:

- WoL is not supported when power save mode set as Mode 3 and Mode4.
- System only turn of backlight when DC off in Mode 3 and Mode 4.
- If user want to power on system in Mode 3 and Mode 4, user can use power on command of RS232 over LAN.

Power LED light

Choose to set power indicate LED on or off.

Choose {On} for normal use.

Network

Launch Network setup and the input source will be changed to Custom for Android network setting.

When exit the network setting, input source will be back to the latest input source.

LED Indicator

LED Status	Power Status	LED behavior
LED Active	Normal ON	Green
	Sleeping	Ambera
	RC command	RED blinking+GREEN
	Schedule on	RED+GREEN blinking(DC Off) If ON TIME is "--:--", the LED is not blinking.
	Standby/DC power off	RED
LED Not-active	Switch off	Blank

Configuration1 reset



Reset all settings in Configuration1 menu to the factory preset values.

Factory reset

Reset all settings in the OSD menus of {Picture}, {Screen}, {Audio}, {PIP}, {Configuration 1}, {Configuration 2}, and {Advanced option} to the factory preset values.

Android settings will also reset when factory reset.

5.1.6. Config2 menu

Configuration 2 Advanced option	OSD turn off OSD H-position OSD V-position OSD transparency Information OSD Logo Monitor ID Heat status Monitor information DP version	 45  50  50 Off 10 Sec On 1 Action Action DP 1.1
------------------------------------	---	--

OSD turn off

Set the period of time the OSD (on-screen display) menu stays on the screen.

The options are: {0 ~ 120} seconds.

NOTE: {0} does not disappear automatically.

OSD H-position

Adjust the horizontal position of the OSD menu.

OSD V-position

Adjust the vertical position of the OSD menu.

OSD Transparency

Adjust OSD transparency.

- {Off} - Transparency off.
- {1-100} - Transparency level 1-100

Information OSD

Set the period of time the information OSD is displayed on the upper right corner of the screen. The information OSD will display when input signal is changed.

The information OSD will remain on the screen with {Off} selection.

The options are: {1 ~ 60} seconds.

Logo

Choose to enable or disable the picture of Logo when turn on your display.

NOTE: Logo will NOT rotate with rotation setting/detection.

Monitor ID

Set the ID number for controlling the display via the RS232C connection.

Each display must have a unique ID number when multiple sets of this display are connected. Monitor ID number range is between 1 to 98.

Heat status

This function allows you to check the thermal status and fan speed of the display at any time.

Monitor information

Shows information about your display, including model number, serial number, operating hours and software version.

DP version

DisplayPort support mode.

The options are:

- **{DP 1.1}**: DP 1.1 single stream (clone mode).
- **{DP 1.2 SST}**: DP 1.2 Single stream (clone mode).
- **{DP 1.2 MST}**: DP 1.2 Multi-Stream

NOTE: The DP version must be set the same for all daisy chain displays.

Window selection

Select the window for adjusting setting. The selected window will be highlight green border.

Window selection will set to Main after power on.

The options are: **{Main}**, **{PIP}**

Rotation

Set the rotation of Main/Sub/OSD

Language

Select the language used in the OSD menu.

The options are: **{English}**/**{Deutsch}**/**{ 简体中文 }**/**{Français}**/**{Italiano}**/**{Español}**/**{Русский}**/**{Polski}**/**{Türkçe}**/**{ 繁體中文 }**

QR Code

Display QR code of Viewsonic website for more information.

Configuration2 reset

Reset all settings in Configuration2 menu to the factory preset values.

5.1.7. Advanced menu

Configuration 2	Input resolution	Auto
Advanced option	IR control	Action
	Keyboard control	Action
	Tiling	Action
	Off timer	Off
	Date and time	Action
	Schedule	Action
	HDMI with One Wire	Off
	Auto signal detection	Action
	Power save	Mode 1

Input resolution

Set the resolution of the VGA input. This is only required when the display is unable to detect the VGA input resolution correctly.

NOTE: This item is functional for VGA input only.

The options are:

- {1024x768 / 1280x768 / 1360x768 / 1366x768}
- {1400x1050 / 1680x1050}
- {1600x1200 / 1920x1200}
- {Auto}: Determines the resolution automatically.

The selected settings will become effective after turning off the power and turning it on again.

IR control

Select the operation mode of the remote control when multiple displays are connected via an RS232C connection.

- {Normal} - All displays can be operated normally by the remote control unit.
- {Primary} - Designate this display as the primary display for remote control operation. Only this display can be operated by the remote control. (In primary mode, IR key will always be processed regardless the monitor id).
- {Secondary} - Designate this display as the secondary display. This display can not be operated by the remote control, and will only receive the control signal from the primary display via the RS232C connection.
- {Lock All} / {Lock all but Volume} / {Lock all but Power} / {Lock all except PWR & VOL} - Lock the remote control function of this display.

NOTE: To unlock IR control, press and hold the [Info] button on the remote control for more 6 (six) seconds.

Keyboard control

Choose to enable or disable the display keyboard (control buttons) function.

- {Unlock} - Enable the keyboard function.
- {Lock All} / {Lock all but Volume} / {Lock all but Power} / {Lock all except PWR & VOL} - Disable the keyboard function.

NOTE:

“Keyboard Control Lock Mode” This function completely disables the access to all Keyboard Control functions. To enable or disable the keyboard control lock, press both [VOL+] and [UP] buttons and hold down continuously for more than 3 (three) seconds.

Tiling

With this function you can create a single large-screen matrix (video wall) that consists of up to 225 sets of this display (up to 15-sets on the vertical and 15-sets on the horizontal sides). This function requires a daisy-chain connection.

Tiling			
H monitor	◀	1	▶
V monitor	◀	1	▶
Position	◀	1	▶
Frame comp.	◀	No	▶
Enable	◀	No	▶
Switch on delay	◀	Off	▶

Example: 2 x 2 screen matrix (4 displays)

H monitors = 2 displays

V monitors = 2 displays

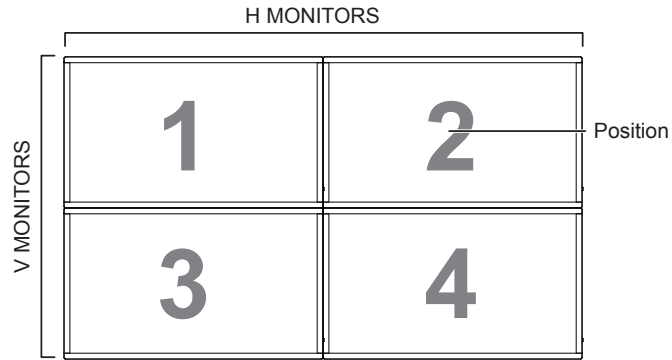

Example: 5 x 5 screen matrix (25 displays)

H monitors = 5 displays

V monitors = 5 displays

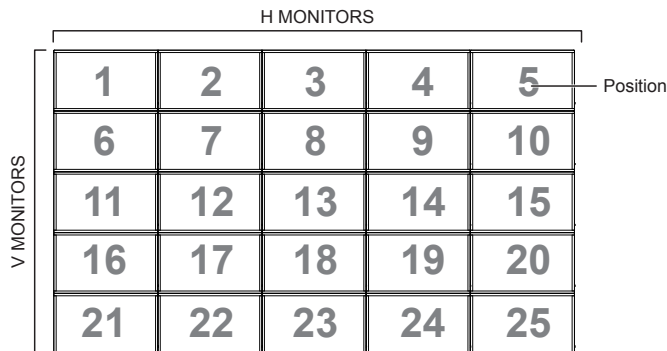

- **{H monitors}** - Select the number of displays on the horizontal side.
- **{V monitors}** - Select the number of displays on the vertical side.
- **{Position}** - Select the position of this display in the screen matrix.
- **{Frame comp.}** - Choose to turn the frame compensation function on or off. If selected **{Yes}**, the display will adjust the image to compensate for the width of the display bezels in order to accurately display the image.

Frame comp. - Yes

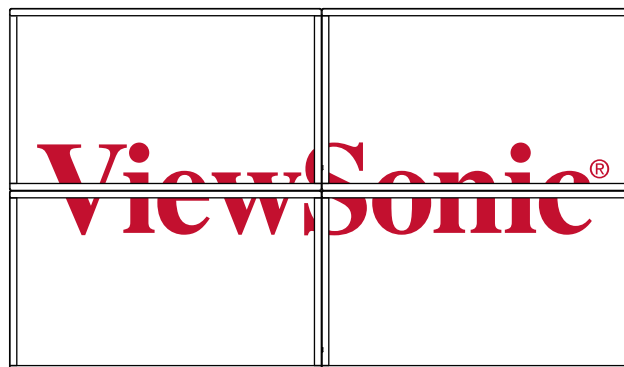

Frame comp. - No

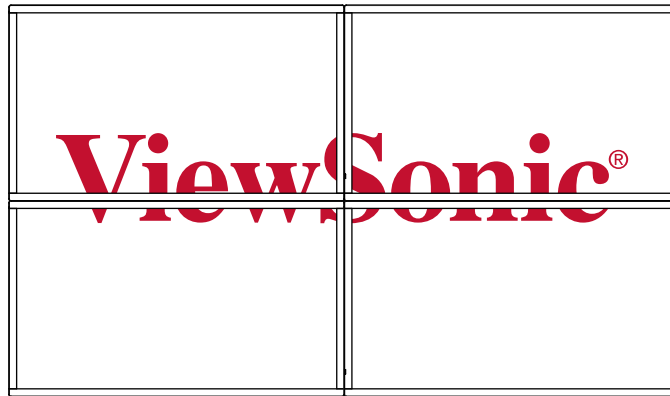

- **{Enable}**: Choose to enable or disable the Tiling function. If enabled, the display will apply the settings in **{H monitors}**, **{V monitors}**, **{Position}**, and **{Frame comp.}**.
- **{Switch on delay}**: Set the power-on delaying time (in seconds). The default option **{Auto}** allows a sequential powering-on for each display by their ID number when multiple displays are connected. The options are:**{Off/Auto/2~255}**

NOTE: The Tiling function will be disabled when the PIP enabled.

Off Timer

Set automatically power off time (in hours).

Date and time

Adjust the current date and time for the display's internal clock.

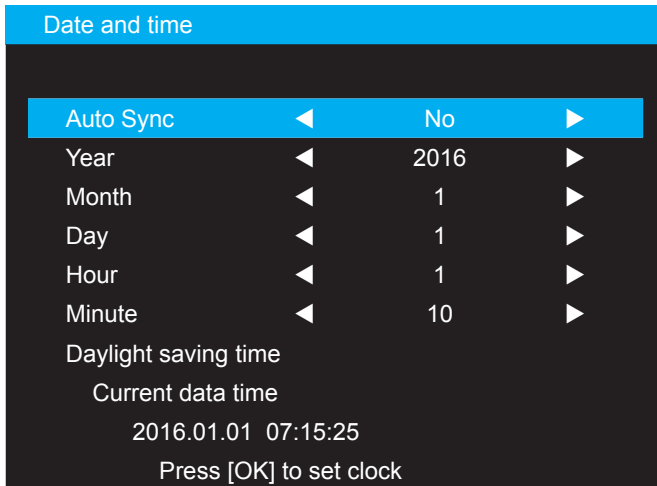

1. Press [OK] button to enter the submenu.
2. Press [▲] or [▼] button to toggle between {Year}, {Month}, {Day}, {Hour}, {Minute}, and {Daylight saving time}.
3. Press [◀] or [▶] button to adjust all settings except {Daylight saving time}.
4. Press [OK] button to enter the {Daylight saving time} submenu.
5. Press [◀] or [▶] button to select item, press [▲] or [▼] button to adjust.

NOTE: Cannot set time to date after year 2037.

Schedule

This function allows you to program up to 7 (seven) different scheduled time intervals for the display to activate.

NOTE: We recommend you to set up current date and time in the {Date and time} menu before using this function.

1. Press [OK] or [▶] button to enter the submenu.

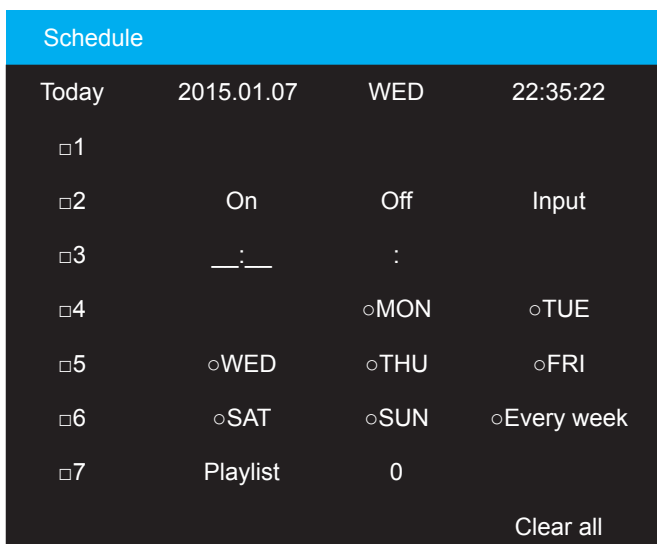

Press [▲] or [▼] button to select a schedule item (item number 1 ~ 7), and then press [+] button to mark it the item number.

2. Press [◀] or [▶] button to select the schedule:

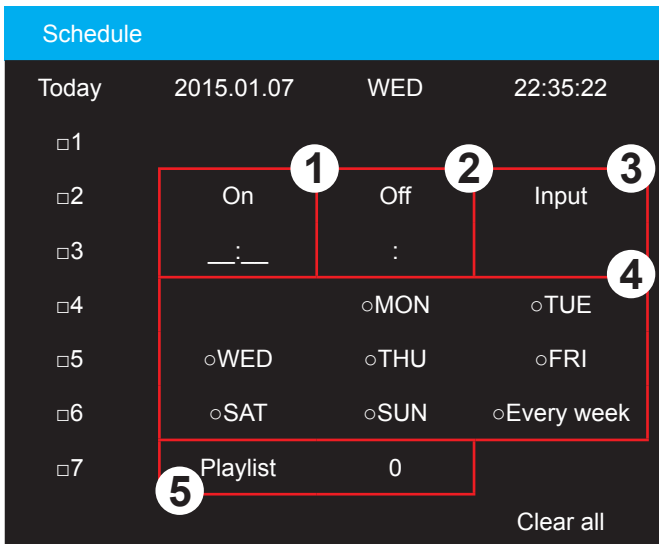

- ① **Power-on** schedule: Press [▲] or [▼] button to set the hour and minute for the display to turn on.
 - ② **Power-off** schedule: Press [▲] or [▼] button to set the hour and minute for the display to turn off. Select or leave an empty “__” for both the hour and minute slot if you do not want to use this power-on or power-off schedule.
 - ③ **Input-source selection**: Press [▲] or [▼] button to select an input source. If no input source is selected, the input source will remain the same as last selected.
 - ④ **Date** schedule: Press [OK] button to select which day in a week this schedule item will be take effect, and then press the [OK] button.
 - ⑤ **Playlist** selection: Press [▲] or [▼] to select the playlist to be played when display power on. Playlist option is only available when input source is android source.
3. For additional schedule settings, press [EXIT], then repeat the steps above. A check mark in the box next to the number of the schedule item indicates that the selected schedule is in effect.
4. Clear all: Clear all sehedule settings.

NOTES:

- If the schedules overlap, the scheduled power-on time takes priority over scheduled power-off time.
- If there are two schedule items programmed for the same time, the highest numbered schedule takes priority. For example, if schedule items #1 and #2 both set the display to power on at 7:00 AM and off at 5:00 PM, then only schedule item # 1 will take effect.

HDMI with One Wire

CEC control.

- **{Off}** - Disable CEC.
- **{On}** - Enable CEC.

Auto signal detection

Choose to let the display detect and display available signal sources automatically.

- **{Off}** - Once a signal is connected, it can only be selected manually.
No signal, set the display to display the image automatically according to the search order of each option.

Power Save

Power save modes

{Mode 1}: DC off -> Power off. LED: Red. Power Save -> Power off, LED: Red

{Mode 2}: DC off -> Power off, LED: Red. Power Save -> Power Saving. LED: Orange. Can be wake up.

{Mode 3}: DC off -> Back light off, LED: Red. Power Save -> Back light off, LED: Orange. Can be wake up.

{Mode 4}: DC off -> Back light off, LED: Red. Power Save -> Will not enter power save mode. show "no signal" only.

NOTE: When Auto FW update is not OFF, display will work under Mode3 for FW update, but OSD item will not change.

Scalar FW Update

Update scalar FW by USB

Auto FW Update

Setup Android FW auto background update time.

NOTE: When Auto FW update is not OFF, display will work under Mode3 for FW update, but OSD item will not change.

USB Cloning

Copy PD settings from one set to another.

Import: Copy settings from file to display

Export: Copy PD settings into file.

NOTE: Cloned data stores in android internal storage. User need to use APK to copy cloned data to another display.

Advanced option reset

Reset all settings in the advanced option menu to factory preset values.

6. USB device compatibility

Type	File Type	Codec	Ability
Photo	JPG, JPEG	JFIF file format 1.02	Decode: Resolution 48X48 to 8176X8176 (1) Not Support Non-interleaved Scan (2) Software support SRGB JPEG (3) Software support Adobe RGB JPEG
	PNG	PNG	Resolution No Restriction
	GIF	GIF	Resolution No Restriction
	BMP	BMP	Resolution No Restriction
Video	DAT, MPG, VOB, TS	MPEG1/2	Supported Image Size:48x48pixels to 1920x1088pixels Maximum Frame Rate:30fps Maximum Bit Rate:80Mbps Audio Codec: MP2, MP3
	AVI, MKV, MP4, MOV, 3GP	MPEG4	Supported Image Size:48x48pixels to 1920x1088pixels Maximum Frame Rate:30fps Maximum Bit Rate:38.4Mbps Audio Codec: MP2, MP3, AC-3 , AAC , DTS,PCM, ADPCM (1) Not support MS MPEG4 v1/v2/v3 (2) Not support GMC(global motion compensation)
	3GP, MOV, MP4	H.263	Supported Image Size:SQCIF(128x96), QCIF(176x144), CIF(352x288),4CIF(704x576) Maximum Frame Rate:30fps Maximum Bit Rate:38.4Mbps Audio Codec: MP3 (1) Not support H.263+
	AVI, MKV, MP4, MOV, 3GP, TS, FLV	H.264	Supported Image Size:48x48pixels to 1920x1088pixels Maximum Frame Rate:30fps Maximum Bit Rate:57.2Mbps Audio Codec: MP2, MP3, AC-3, AAC, DTS, PCM,ADPCM (1) Not support MBAFF
	WEBM	VP8	Supported Image Size:48x48pixels to 1920x1088pixels Maximum Frame Rate:30fps Maximum Bit Rate:38.4Mbps Audio Codec: Ogg Vorbis
	WMV, ASF, TS, MKV, AVI	VC1	Supported Image Size:48x48pixels to 1920x1088pixels Maximum Frame Rate:30fps Maximum Bit Rate:45Mbps Audio Codec: MP2, MP3, AC-3 , AAC, DTS ,WMA
Audio	MP1, MP2, MP3	MPEG1/2/2.5 Audio Layer1/2/3	Bit Rate: 8kbps~320Kbps, CBR and VBR Sampling Rate: 8KHZ~48KHz
	WMA	WMA Version 4,4.1, 7, 8, 9, wmapro	Bit Rate: 8kbps~320Kbps Sampling Rate: 8KHZ~48KHz Non-support WMA Pro, lossless and MBR
	AAC, M4A	MAIN, ADIF, ATDS Header AAC-LC and AAC-HE	Bit Rate: N/A Sampling Rate: 8KHZ~48KHz

7. Input mode

PC Resolution:

Standard Resolution	Active Resolution		Refresh Rate	Pixel Rate	Aspect Ratio	Stand for Mode
	H Pixels	V Lines				
VGA	640	480	60 Hz	25.175 MHz	4:3	Video Graphic Array
		480	72 Hz	31.5 MHz		
		480	75 Hz	31.5 MHz		
WVGA	720	400	70 Hz	33.75 MHz	16:9	Wide Video Graphic Array
SVGA	800	600	60 Hz	40 MHz	4:3	Super VGA
		600	75 Hz	49.5 MHz		
XGA	1024	768	60 Hz	65 MHz	4:3	Extended Graphic Array
		768	75 Hz	78.75 MHz		
WXGA	1280	768	60 Hz	79.5 MHz	5:3	Wide XGA
WXGA	1280	800	60 Hz	79.5 MHz	16:10	Wide XGA
SXGA	1280	1024	60 Hz	108 MHz	5:4	Super XGA
WXGA	1360	768	60 Hz	85.5 MHz	16:9	Wide XGA
UXGA	1600	1200	60 Hz	162 MHz	4:3	Ultra XGA
HD1080	1920	1080	60 Hz	148.5 MHz	16:9	HD1080

SDTV Resolution:

Standard Resolution	Active Resolution		Refresh Rate	Pixel Rate	Aspect Ratio	Stand for Mode
	H Pixels	V Lines				
480i	720	480	29.97 Hz	13.5 MHz	4:3	Modified NTSC Standard
480p			59.94 Hz	27 MHz		
576i	720	480	25 Hz	13.5 MHz	4:3	Modified PAL Standard
576p			50 Hz	27 MHz		

HDTV Resolution:

Standard Resolution	Active Resolution		Refresh Rate	Pixel Rate	Aspect Ratio	Stand for Mode
	H Pixels	V Lines				
720p	1280	720	50 Hz	74.25 MHz	16:9	Normally DVB Mode
			60 Hz			
1080i	1920	1080	25 Hz	74.25 MHz	16:9	Normally ATSC Mode
			30 Hz			
1080p	1920	1080	50 Hz	148.5 MHz	16:9	Normally ATSC Mode
			60 Hz			
4K2K ^{*1*2}	3840	2160	30 Hz	262.75 MHz	16:9	

NOTE: Technical specifications are subject to change without notice.

*1: Displayed text may be blurred.

*2: 4K2K timing only support on HDMI and DisplayPort input source.

Recommend graphic card for timing 4K2K@30Hz as below.

AMD: Radeon R9 290X, Radeon R9 270X, Radeon HD7850, FirePro W5000, Radeon R7 260X.

NVIDIA: Geforce GTX770, Geforce GTX Titan, Geforce GTX660, Geforce GTX980, Geforce GTX960.

- The PC text quality is optimized in HD 1080 mode (1920 × 1080, 60 Hz).
- Your PC display screen might appear different depending on the manufacturer (and your particular version of Windows).
- Check your PC instruction book for information about connecting your PC to a display.
- When horizontal synchronous signals seem irregular in RGB mode, check PC power saving mode or cable connections.
- This display settings table complies with the IBM/VESA standards, and based on the analog input.
- The DVI support mode is regarded to be the same as the PC support mode.
- The best vertical frequency timing for each mode is 60Hz.

8. Cleaning and Troubleshooting

8.1. Cleaning

When Using the Display

- Do not bring your hands, face or objects close to the ventilation holes of the display. The top of the display is usually very hot due to the high temperature of exhaust air being released through the ventilation holes. Burns or personal injuries may occur if any body parts are brought too close. Placing any object near the top of the display could also result in heat related damage to the object as well as the display itself.
- Be sure to disconnect all cables before moving the display. Moving the display with its cables attached may damage the cables and thus cause fire or electric shock.
- Disconnect the power plug from the wall outlet as a safety precaution before carrying out any type of cleaning or maintenance procedure.

Front Panel Cleaning Instructions

- The front of the display has been specially treated. Wipe the surface gently using only a cleaning cloth or a soft, lint-free cloth.
- If the surface becomes dirty, soak a soft, lint-free cloth in a mild detergent solution. Wring the cloth to remove excess liquid. Wipe the surface of the display to remove dirt. Then use a dry cloth of the same type to dry.
- Do not scratch or hit the surface of the panel with fingers or hard objects of any kind.
- Do not use volatile substances such as insert sprays, solvents and thinners.

Cabinet Cleaning Instructions

- If the cabinet becomes dirty, wipe the cabinet with a soft, dry cloth.
- If the cabinet is extremely dirty, soak a lint-free cloth in a mild detergent solution. Wring the cloth to remove as much moisture as possible. Wipe the cabinet. Use another dry cloth to wipe over until the surface is dry.
- Do not allow any water or detergent to come into contact with the surface of the display. If water or moisture gets inside the unit, operating problems, electrical and shock hazards may result.
- Do not scratch or hit the cabinet with fingers or hard objects of any kind.
- Do not use volatile substances such as insert sprays, solvents and thinners on the cabinet.
- Do not place anything made from rubber or PVC near the cabinet for any extended periods of time.

8.2. Troubleshooting

Symptom	Possible Cause	Remedy
No picture is displayed	<ol style="list-style-type: none"> 1. The power cord is disconnected. 2. The main power switch on the back of the display is not switched on. 3. The selected input has no connection. 4. The display is in standby mode. 	<ol style="list-style-type: none"> 1. Plug in the power cord. 2. Make sure the power switch is switched on. 3. Connect a signal connection to the display.
Interference displayed on the display or audible noise is heard	Caused by surrounding electrical appliances or fluorescent lights.	Move the display to another location to see if the interference is reduced.
Color is abnormal	The signal cable is not connected properly.	Make sure that the signal cable is attached firmly to the back of the display.
Picture is distorted with abnormal patterns	<ol style="list-style-type: none"> 1. The signal cable is not connected properly. 2. The input signal is beyond the capabilities of the display. 	<ol style="list-style-type: none"> 1. Make sure that the signal cable is attached firmly. 2. Check the video signal source to see if it is beyond the range of the display. Please verify its specifications with this display's specification section.
Display image doesn't fill up the full size of the screen	Zoom mode is not correctly set.	Use the Zoom mode or Custom zoom function in the Screen menu to fine tune display geometry and time frequency parameter.
Can hear sound, but no picture	Improperly connected source signal cable.	Make sure that both video inputs and sound inputs are correctly connected.
Can see picture but no sound is heard	<ol style="list-style-type: none"> 1. Improperly connected source signal cable. 2. Volume is turned all the way down. 3. [MUTE] is turned on. 4. No external speaker connected. 	<ol style="list-style-type: none"> 1. Make sure that both video inputs and sound inputs are correctly connected. 2. Press [VOL DOWN] or [VOL UP] button to hear sound. 3. Switch MUTE off by using the  [MUTE] button. 4. Connect external speakers and adjust the volume to a suitable level.
Some picture elements do not light up	Some pixels of the display may not turn on.	This display is manufactured using an extremely high level of precision technology: however, sometimes some pixels of the display may not display. This is not a malfunction.
After-Images can still be seen on the display after the display is powered off. (Examples of still pictures include logos, video games, computer images, and images displayed in 4:3 normal mode)	A still picture is displayed for an over extended period of time	Do not allow a still image to be displayed for an extended period of time as this can cause a permanent after-image to remain on the display.

9. Technical Specifications

9.1. CDM5500T

Display:

Item	Specifications
Screen Size (Active Area)	54.64" LCD (139.7 cm)
Aspect Ratio	16:9
Number of Pixels	1920 (H) × 1080 (V)
Pixel Pitch	0.630 (H) × 0.630 (V) [mm]
Displayable Colors	16.7 Million colors
Brightness	450 cd/m ²
Contrast Ratio (Typical)	1100:1
Viewing Angle	178 degrees

In/Out Terminals:

Item	Specifications
Speaker Output	Internal Speakers 10W (L) + 10W (R) [RMS]/8Ω, 1 Way 1 Speaker System 82 dB/W/M/160 Hz ~ 13 KHz
Audio Output	3.5mm jack x 1 0.5V [rms] (Normal) / 2 Channel (L+R)
Audio Input	3.5 mm Stereo × 1 RCA Jack × 2 0.5V [rms] (Normal) / 2 Channel (L+R)
RS232C Input/ Output	2.5mm jack x 2 RS232C in/RS232C out
LAN	RJ-45 Jack × 1 (8 pin) 10/100 LAN Port
HDMI Input	HDMI Jack × 2 (Type A) (19 pin) Digital RGB: TMDS (Video + Audio) MAX: Video: 720p, 1080p, 1920 × 1080/60 Hz (WUXGA) Audio: 48 KHz / 2 Channel (L+R) Supports LPCM only
DVI-I (DVI & VGA) in/out	DVI-I Jack x 1 (29 pin) Digital RGB: TMDS (Video) Analog RGB: 0.7V [p-p] (75Ω), H/CS/V: TTL (2.2kΩ), SOG: 1V [p-p] (75Ω) MAX: 720p, 1080p, 1920 x 1080/60 Hz (WUXGA)
Displayport in/out	Displayport Jack x 2 (20 pin) Digital RGB: TMDS (Video + Audio) MAX: Video - 720p, 1080p, 1920 x 1080/60 Hz (WUXGA) Audio - 48 KHz/ 2 Channel (L+R) Supports LPCM only
IR Input/Output	3.5mm Jack x 2 IR pass through or IR daisy chain
USB Port	USB × 2 (Type A) Multi Media x 1, 5V/2A x 1

General:

Item	Specifications
Power Input	100-240V~ 50-60Hz
Power Consumption (Max.)	143W
Power Consumption (Typical)	76W
Power Consumption (Standby & Off)	< 0.5W
Dimensions [W × H × D]	1271.0 x 741.8 x 64.0 mm
Weight	31.0 Kg
Gross Weight	39.6 Kg

Environmental Condition:

Item		Specifications
Temperature	Operational	0 ~ 40°C
	Storage	-20 ~ 60°C
Humidity	Operational	20~80% (without condensation)
	Storage	10~90% (without condensation) “90-3.5x(Temp-40[°C])” % regarding over 40 °C
Altitude	Operational	0 ~ 2,000 m
	Storage	0 ~ 5,000 m

Touch specification:

	Item	Specifications
Touch Panel	Touch Method and Object size	Finger or Stylus (6pts or 10pts)
	Number of Touch	10
	Touch Accuracy	5mm with 8mm stylus (Min)
	Communication	USB 2.0
	PC connector	USB type B
	Operating System	Windows 7, 8/8.1, 10 Mac OSX 10.10+ (include) Linux kernel 3.0 above Android OS 4.0+ (Kernel 3.5+)
	Touch control priority	If touch out is connected to external PC, internal touch will be disabled.

10. RS232 Protocol

10.1. Introduction

This document describes the hardware interface spec and software protocols of RS232 interface communication between ViewSonic Commercial TV / Digital Signage and PC or other control unit with RS232 protocol.

The protocol contains three sections command:

- Set-Function
- Get-Function
- Remote control pass-through mode

* In the document below, "PC" represents all the control units that can send or receive the RS232 protocol command.

10.2. Description

10.2.1. Hardware specification

Viewsonic TV communication port on the rear side:

(1) Connector type: DSUB 9-Pin Male

(2) Pin Assignment

Male DSUB 9-Pin
(outside view)



Pin #	Signal	Remark
1	NC	
2	RXD	Input to Commercial TV or DS
3	TXD	Output from Commercial TV or DS
4	NC	
5	GND	
6	NC	
7	NC	
8	NC	
9	NC	
frame	GND	

* Use of crossover (null modem) cable required for use with PC

[Special case] 3.5mm barrel connector

Pin #	Signal	Remark
Tip	TXD	Output from Commercial TV or DS
Ring	RXD	Input to Commercial TV or DS
Sleeve	GND	

10.2.2. Communication Setting

- Baud Rate Select: 9600bps (fixed)
- Data bits: 8 bits (fixed)
- Parity: None (fixed)
- Stop Bits: 1 (fixed)

10.2.3. Command Message Reference

PC sends to Monitor command packet followed by "CR". Every time PC sends control command to the Monitor, the Monitor shall respond as follows:

1. If the message is received correctly it will send "+" (02Bh) followed by "CR" (00Dh)
2. If the message is received incorrectly it will send "-" (02Dh) followed by "CR" (00Dh)

10.3. Protocol

10.3.1. Set-Function Listing

The PC can control the TV/DS for specific actions. The Set-Function command allows you to control the TV/DS behavior in a remote site through the RS232 port. The Set-Function packet format consists of 9 bytes.

Set-Function description:

Length:	Total Byte of Message excluding "CR".
TV/DS ID	Identification for each of TV/DS (01~98; default is 01) If we want to set all TV/DS settings, use the TV/DS ID "99", and it will not have Reply command on this function. The TV/DS ID can be set via the OSD menu for each TV/DS set.
Command Type	Identify command type, "s" (0x73h) : Set Command "+" (0x2Bh) : Valid command Reply "- " (0x2Dh) : Invalid command Reply
Command:	Function command code: One byte ASCII code.
Value[1~3]:	Three bytes ASCII that defines the value.
CR	0x0D

Set-Function format

Send: (Command Type="s")

Name	Length	ID	Command Type	Command	Value1	Value2	Value3	CR
Byte Count	1 Byte	2 Byte	1 Byte	1 Byte	1 Byte	1 Byte	1 Byte	1 Byte
Bytes order	1	2~3	4	5	6	7	8	9

NOTE: For VT2405LED-1 and VT3205LED, the set "Power on" command is the exception

Reply: (Command Type="+" or "-")

Name	Length	ID	Command Type	CR
Byte Count	1 Byte	2 Byte	1 Byte	1 Byte
Bytes order	1	2~3	4	5

NOTE:

- The reply for "Power on" command is the exception for VT2405LED-1 and VT3205LED. It's 0x322B0D (2+<CR>).
- When PC applies command to all displays (ID=99), only the #1 set needs to reply by the name of ID=1.

Example1: Set Brightness as 76 for TV-02 and this command is valid

Send (Hex Format)

Name	Length	ID	Command Type	Command	Value1	Value2	Value3	CR
Hex	<u>0x38</u>	<u>0x30</u> <u>0x32</u>	<u>0x73</u>	<u>0x24</u>	<u>0x30</u>	<u>0x37</u>	<u>0x36</u>	<u>0x0D</u>

Reply (Hex Format)

Name	Length	ID	Command Type	CR
Hex	<u>0x34</u>	<u>0x30</u> <u>0x32</u>	<u>0x2B</u>	<u>0x0D</u>

Example2: Set Brightness as 176 for TV-02 and this command is NOT valid Send (Hex Format)

Name	Length	ID	Command Type	Command	Value1	Value2	Value3	CR
Hex	0x38	0x30 0x32	0x73	0x24	0x31	0x37	0x36	0x0D

Reply (Hex Format)

Name	Length	ID	Command Type	CR
Hex	0x34	0x30 0x32	0x2D	0x0D

Set function table:

Set Function	Length	ID	Command Type	Command		Value Range (Three ASCII bytes)	Comments
				Code (ASCII)	Code (Hex)		
Power on/off (standby)	8		s	!	21	000: STBY 001: ON	Controlled power status: ON or Standby
Input Select	8		s	"	22	000 : TV 001 : AV 002 : S-Video 003 : YPbPr 004 : HDMI 014 : HDMI2 024 : HDMI3 005 : DVI 006 : VGA1(PC) 016 : VGA2 007 : OPS 008 : Internal Mem 009 : DP	1. No need for USB 2. For the case of two more same sources, the 2nd digital is used to indicate the extension.
Contrast	8		s	#	23	000 ~ 100	
Brightness	8		s	\$	24	000 ~ 100	
Sharpness	8		s	%	25	000 ~ 100	
Color	8		s	&	26	000 ~ 100	
Tint	8		s	'	27	000 ~ 100	
Color Mode	8		s)	29	000 : Normal 001 : Warm 002 : Cold 003 : Personal	
Bass	8		s	.	2E	000 ~ 100	Sets Bass value
Treble	8		s	/	2F	000 ~ 100	Sets Treble value
Balance	8		s	0	30	000 ~ 100	Sets Balance position
Picture Size	8		s	1	31	000 : FULL 001 : NORMAL 002 : CUSTOM 003 : DYNAMIC 004 : REAL	
OSD Language	8		s	2	32	000 : English 001 : French 002 : Spanish	
Power Lock	8		s	4	34	000 : Unlock 001 : Lock	
Volume	8		s	5	35	000 ~ 100 900 : Volume down (-1) 901 : Volume up (+1)	

Mute	8		s	6	36	000: OFF 001: ON (mute)	
Button Lock	8		s	8	38	000 : Unlock 001 : Lock	
Menu Lock	8		s	>	3E	000 : Unlock 001 : Lock	
Key Pad	8		s	A	41	000 : UP 001 : DOWN 002 : LEFT 003 : RIGHT 004 : ENTER 005 : INPUT 006 : MENU/EXIT	
Remote Control	8		s	B	42	000: Disable	Disable: RCU has no effect on Monitor.
						001: Enable	Enabled: RCU controls the Monitor. This is the power up default on the Monitor.
						002: Pass through	Pass through: RCU has no effect on Monitor and all RCU command codes are transmitted to PC via the RS232 port.
Date	8		s	V	56	0xx: Year 1xx: Month+Day (See example in Note)	For specific models only
Tiling-Mode	8		s	P	50	000: OFF 001: ON	(for DS)
Tiling-Compensation	8		s	Q	51	000: OFF 001: ON	(for DS) Bezel width compensation
Tiling-H by V Monitors	8		s	R	52	01x~09x: H 0x1~0x9: V	(for DS) 1. 2 nd digital for H monitors 2. 3 rd digital for V monitors
Tiling-Position	8		s	S	53	001~025	(for DS) Copy the screen of Position# to identified display
Time	8		s	W	57	0xx: Hour+Min 10x: Sec (See example in Note)	For specific models only
Factory reset	8		s	~	7E	0	Rests Monitor to factory setting

10.3.2. Get-Function Listing

The PC can interrogate the TV/DS for specific information. The Get-Function packet format consists of 9 bytes which is similar to the Set-Function packet structure. Note that the "Value" byte is always = 000

Get-Function description:

- Length:** Total Byte of Message excluding "CR".
- TV/DS ID** Identification for each of TV/DS (01~98; default is 01).
- Command Type** Identify command type,
 "g" (0x67h) : Get Command
 "r" (0x72h) : Valid command Reply
 "-" (0x2Dh) : Invalid command Reply
- Command:** Function command code: One byte ASCII code.
- Value[1~3]:** Three bytes ASCII that defines the value.
- CR** 0x0D

Get-Function format

Send: (Command Type="g")

Name	Length	ID	Command Type	Command	Value1	Value2	Value3	CR
Byte Count	1 Byte	2 Byte	1 Byte	1 Byte	1 Byte	1 Byte	1 Byte	1 Byte
Bytes order	1	2~3	4	5	6	7	8	9

NOTE: "Power STBY status" is the exception for VT2405LED-1 and VT3205LED.

Reply: (Command Type="r" or "-")

If the Command is valid, Command Type = "r"

Name	Length	ID	Command Type	Command	Value1	Value2	Value3	CR
Byte Count	1 Byte	2 Byte	1 Byte	1 Byte	1 Byte	1 Byte	1 Byte	1 Byte
Bytes order	1	2~3	4	5	6	7	8	9

NOTE: The reply for "Power STBY status" command is the exception for VT2405LED-1 and V3205LED. It's 0x36 72 6C 30 30 30 0D (6rl000<CR>).

If the Command is Not valid, Command Type="-"

Name	Length	ID	Command Type	CR
Byte Count	1 Byte	2 Byte	1 Byte	1 Byte
Bytes order	1	2~3	4	5

Example1: Get Brightness from TV-05 and this comm and is valid. The Brightness value is 67.

Send (Hex Format)

Name	Length	ID	Command Type	Command	Value1	Value2	Value3	CR
Hex	<u>0x38</u>	<u>0x30</u> <u>0x35</u>	<u>0x67</u>	<u>0x62</u>	<u>0x30</u>	<u>0x30</u>	<u>0x30</u>	<u>0x0D</u>

Reply (Hex Format)

Name	Length	ID	Command Type	Command	Value1	Value2	Value3	CR
Hex	<u>0x38</u>	<u>0x30</u> <u>0x35</u>	<u>0x72</u>	<u>0x62</u>	<u>0x30</u>	<u>0x36</u>	<u>0x37</u>	<u>0x0D</u>

Example2: Get Brightness from TV-05, but the Brightness command ID is error and it is NOT in the command table.

Send (Hex Format)

Name	Length	ID	Command Type	Command	Value1	Value2	Value3	CR
Hex	<u>0x38</u>	<u>0x30</u> <u>0x35</u>	<u>0x67</u>	<u>0XD3</u>	<u>0x30</u>	<u>0x30</u>	<u>0x30</u>	<u>0x0D</u>

Reply (Hex Format)

Name	Length	ID	Command Type	CR
Hex	<u>0x34</u>	<u>0x30</u> <u>0x35</u>	<u>0x2D</u>	<u>0x0D</u>

Get function table:

Get Function	Length	ID	Command Type	Command		Value Range (Three ASCII bytes)	Comments
				Code (ASCII)	Code (Hex)		
Get-Contrast	8		g	a	61	000 ~ 100	Gets Contrast value
Get-Brightness	8		g	b	62	000 ~ 100	Gets Brightness value
Get-Sharpness	8		g	c	63	000 ~ 100	Gets Sharpness value
Get-Color	8		g	d	64	000 ~ 100	Gets Color value
Get-Tint	8		g	e	65	000 ~ 100	Gets Tint value
Get-Volume	8		g	f	66	000 ~ 100	Gets Volume value
Get-Mute	8		g	g	67	000: OFF (unmuted) 001: ON (muted)	Gets Mute ON/OFF status
Get-Input select	8		g	j	6A	000~	See Set-function table
Get-Power status : ON/STBY	8		g	l	6C	000: STBY 001: ON	
Get-Remote control	8		g	n	6E	000 : Disable 001 : Enable 002 : Pass through	
Get-Power Lock	8		g	o	6F	000 : Unlock 001 : Lock	
Get-Button Lock	8		g	p	70	000 : Unlock 001 : Lock	
Get-Menu Lock	8		g	q	71	000 : Unlock 001 : Lock	
Get-Tiling Mode	8		g	v	76	000: OFF 001: ON	(for DS)
Get-Tiling Compensation	8		g	w	77	000: OFF 001: ON	(for DS) Bezel width compensation
Get-Tiling H by V monitors	8		g	x	78	01x~09x: H monitors 0x1~0x9: V monitors	(for DS) 1. 2 nd digital for H monitors 2. 3 rd digital for V monitors
Get-Tiling position	8		g	y	79	000: OFF 001~025	(for DS) Copy the screen of Position# to identified display
Get-ACK	8		g	z	7A	000	This command is used to test the communication link.
Get-Thermal	8		g	0	30	000~100: 0~+100 deg C -01~-99: -1~-99 deg C	For specific models only
Get-Power on/off log	8		g	1	31	000 (See below note)	For specific models only
Get-Date	8		g	2	32	000 (See the Set-Date command)	For specific models only
Get- Time	8		g	3	33	000 (See the Set-Time command)	For specific models only

10.3.3.Remote Control Pass-through mode

When the PC sets the TV/DS to Remote Control Pass through mode, the TV/DS will send a 7-byte packet (followed by “CR”) in response to RCU button activation. Note, that in this mode the RCU shall have no effect on the TV/DS function. For example: “Volume+” will not change the volume in the LCD but only sends “Volume+” code to PC over the RS232 port.

IR Pass Through-Function format

Reply: (Command Type=“p”)

Name	Length	ID	Command Type	RCU Code1 (MSB)	RCU Code2 (LSB)	CR
Byte Count	1 Byte	2 Byte	1 Byte	1 Byte	1 Byte	1 Byte
Bytes order	1	2~3	4	5	6	7

Example1: Remote Control pass-through when “VOL+” key is pressed for TV-05 Send (Hex Format)

Name	Length	ID	Command Type	Command	Value1	CR
Hex	<u>0x36</u>	<u>0x30</u> <u>0x35</u>	<u>0x70</u>	<u>0x31</u>	<u>0x30</u>	<u>0x0D</u>

Key	Code (HEX)
1	01
2	02
3	03
4	04
5	05
6	06
7	07
8	08
9	09
0	0A
-	0B
RECALL (LAST)	0C
INFO (DISPLAY)	0D
	0E
ASPECT (ZOOM, SIZE)	0F
VOLUME UP (+)	10
VOLUME DOWN (-)	11
MUTE	12
CHANNEL/PAGE UP (+)/ BRIGHTNESS+	13
CHANNEL/PAGE DOWN (-)/ BRIGHTNESS-	14
POWER	15
SOURCES (INPUTS)	16
	17
	18
SLEEP	19
MENU	1A
UP	1B
DOWN	1C
LEFT (-)	1D
RIGHT (+)	1E
OK (ENTER, SET)	1F
EXIT	20
	21
	22
	23
	24
	25
	26
	27
	28
	29
	2A
	2B
RED ■ (F1)	2C
GREEN ■ (F2)	2D
YELLOW ■ (F3)	2E
BLUE ■ (F4)	2F

NOTE:

1. This IR-pass-through code is different from the RCU key code.
2. Special control sequence for POWER key under IR-pass through mode.
 - 2-1. When TV/DS is OFF and receives the IR POWER code: TV/DS will turn itself on, then forward the POWER code to the host via RS232.
 - 2-2. When TV/DS is ON and receives the IR POWER code: TV/DS will forward the POWER code to the host via RS232, then turn off itself.
 - 2-3. When SET-POWER LOCK is enabled, the TV/DS will not respond to POWER key pressing.
3. The VOLUME UP and VOLUME DOWN code will repeatedly output when you press and hold the keys.

11. Other Information

Customer Support

For technical support or product service, see the table below or contact your reseller.

NOTE: You will need the product serial number.

Country/Region	Website	T = Telephone C = CHAT ONLINE	Email
Australia New Zealand	www.viewsonic.com.au	AUS= 1800 880 818 NZ= 0800 008 822	service@au.viewsonic.com
Canada	www.viewsonic.com	T= 1-866-463-4775	service.ca@viewsonic.com
Europe	www.viewsoniceurope.com	www.viewsoniceurope.com/uk/support/call-desk/	
Hong Kong	www.hk.viewsonic.com	T= 852 3102 2900	service@hk.viewsonic.com
India	www.in.viewsonic.com	T= 1800 419 0959	service@in.viewsonic.com
Korea	ap.viewsonic.com/kr/	T= 080 333 2131	service@kr.viewsonic.com
Latin America (Argentina)	www.viewsonic.com/la/	C= http://www.viewsonic.com/la/soporte/servicio-tecnico	soporte@viewsonic.com
Latin America (Chile)	www.viewsonic.com/la/	C= http://www.viewsonic.com/la/soporte/servicio-tecnico	soporte@viewsonic.com
Latin America (Columbia)	www.viewsonic.com/la/	C= http://www.viewsonic.com/la/soporte/servicio-tecnico	soporte@viewsonic.com
Latin America (Mexico)	www.viewsonic.com/la/	C= http://www.viewsonic.com/la/soporte/servicio-tecnico	soporte@viewsonic.com
Nexus Hightech Solutions, Cincinnati #40 Desp. 1 Col. De los Deportes Mexico D.F. Tel: 55) 6547-6454 55)6547-6484 Other places please refer to http://www.viewsonic.com/la/soporte/servicio-tecnico#mexico			
Latin America (Peru)	www.viewsonic.com/la/	C= http://www.viewsonic.com/la/soporte/servicio-tecnico	soporte@viewsonic.com
Macau	www.hk.viewsonic.com	T= 853 2870 0303	service@hk.viewsonic.com
Middle East	ap.viewsonic.com/me/	Contact your reseller	service@ap.viewsonic.com
Puerto Rico & Virgin Islands	www.viewsonic.com	T= 1-800-688-6688 (English) C= http://www.viewsonic.com/la/soporte/servicio-tecnico	service.us@viewsonic.com soporte@viewsonic.com
Singapore/ Malaysia/ Thailand	www.viewsonic.com.sg	T= 65 6461 6044	service@sg.viewsonic.com
South Africa	ap.viewsonic.com/za/	Contact your reseller	service@ap.viewsonic.com
United States	www.viewsonic.com	T= 1-800-688-6688	service.us@viewsonic.com

Limited Warranty

ViewSonic® LCD Commercial Display

What the warranty covers:

ViewSonic warrants its products to be free from defects in material and workmanship, under normal use, during the warranty period. If a product proves to be defective in material or workmanship during the warranty period, ViewSonic will, at its sole option, repair or replace the product with a like product. Replacement product or parts may include remanufactured or refurbished parts or components.

Who the warranty protects:

This warranty is valid only for the first consumer purchaser.

What the warranty does not cover:

1. Any product on which the serial number has been defaced, modified or removed.
2. Damage, deterioration or malfunction resulting from:
 - a. Accident, misuse, neglect, fire, water, lightning, or other acts of nature, unauthorized product modification, or failure to follow instructions supplied with the product.
 - b. Any damage of the product due to shipment.
 - c. Removal or installation of the product.
 - d. Causes external to the product, such as electrical power fluctuations or failure.
 - e. Use of supplies or parts not meeting ViewSonic's specifications.
 - f. Normal wear and tear.
 - g. Any other cause which does not relate to a product defect.
3. Any product exhibiting a condition commonly known as "image burn-in" which results when a static image is displayed on the product for an extended period of time.
4. Removal, installation, one way transportation, insurance, and set-up service charges.

How to get service:

1. For information about receiving service under warranty, contact ViewSonic Customer Support (Please refer to Customer Support page). You will need to provide your product's serial number.
2. To obtain warranty service, you will be required to provide (a) the original dated sales slip, (b) your name, (c) your address, (d) a description of the problem, and (e) the serial number of the product.
3. Take or ship the product freight prepaid in the original container to an authorized ViewSonic service center or ViewSonic.
4. For additional information or the name of the nearest ViewSonic service center, contact ViewSonic.

Limitation of implied warranties:

There are no warranties, express or implied, which extend beyond the description contained herein including the implied warranty of merchantability and fitness for a particular purpose.

Exclusion of damages:

ViewSonic's liability is limited to the cost of repair or replacement of the product. ViewSonic shall not be liable for:

1. Damage to other property caused by any defects in the product, damages based upon inconvenience, loss of use of the product, loss of time, loss of profits, loss of business opportunity, loss of goodwill, interference with business relationships, or other commercial loss, even if advised of the possibility of such damages.
2. Any other damages, whether incidental, consequential or otherwise.
3. Any claim against the customer by any other party.
4. Repair or attempted repair by anyone not authorized by ViewSonic.

Effect of state law:

This warranty gives you specific legal rights, and you may also have other rights which vary from state to state. Some states do not allow limitations on implied warranties and/or do not allow the exclusion of incidental or consequential damages, so the above limitations and exclusions may not apply to you.

Sales outside the U.S.A. and Canada:

For warranty information and service on ViewSonic products sold outside of the U.S.A. and Canada, contact ViewSonic or your local ViewSonic dealer.

The warranty period for this product in mainland China (Hong Kong, Macao and Taiwan Excluded) is subject to the terms and conditions of the Maintenance Guarantee Card.

For users in Europe and Russia, full details of warranty provided can be found in www.viewsoniceurope.com under Support/Warranty Information.

Mexico Limited Warranty

ViewSonic® LCD Commercial Display

What the warranty covers:

ViewSonic warrants its products to be free from defects in material and workmanship, under normal use, during the warranty period. If a product proves to be defective in material or workmanship during the warranty period, ViewSonic will, at its sole option, repair or replace the product with a like product. Replacement product or parts may include re-manufactured or refurbished parts or components.

Who the warranty protects:

This warranty is valid only for the first consumer purchaser.

What the warranty does not cover:

1. Any product on which the serial number has been defaced, modified or removed.
2. Damage, deterioration or malfunction resulting from:
 - a. Accident, misuse, neglect, fire, water, lightning, or other acts of nature, unauthorized product modification, or failure to follow instructions supplied with the product.
 - b. Any damage of the product due to shipment.
 - c. Removal or installation of the product.
 - d. Causes external to the product, such as electrical power fluctuations or failure.
 - e. Use of supplies or parts not meeting ViewSonic's specifications.
 - f. Normal wear and tear.
 - g. Any other cause which does not relate to a product defect.
3. Any product exhibiting a condition commonly known as "image burn-in" which results when a static image is displayed on the product for an extended period of time.
4. Removal, installation, one way transportation, insurance, and set-up service charges.

How to get service:

For information about receiving service under warranty, contact ViewSonic Customer Support (Please refer to the attached Customer Support page). You will need to provide your product's serial number, so please record the product information in the space provided below on your purchase for your future use. Please retain your receipt of proof of purchase to support your warranty claim.

For Your Records

Product Name: _____

Model Number: _____

Document Number: _____

Serial Number: _____

Purchase Date: _____

Extended Warranty Purchase? _____ (Y/N)

If so, what date does warranty expire? _____

1. To obtain warranty service, you will be required to provide (a) the original dated sales slip, (b) your name, (c) your address, (d) a description of the problem, and (e) the serial number of the product.
2. Take or ship the product in the original container packaging to an authorized ViewSonic service center.
3. Round trip transportation costs for in-warranty products will be paid by ViewSonic.

Limitation of implied warranties:

There are no warranties, express or implied, which extend beyond the description contained herein including the implied warranty of merchantability and fitness for a particular purpose.

Exclusion of damages:

ViewSonic's liability is limited to the cost of repair or replacement of the product. ViewSonic shall not be liable for:

1. Damage to other property caused by any defects in the product, damages based upon inconvenience, loss of use of the product, loss of time, loss of profits, loss of business opportunity, loss of goodwill, interference with business relationships, or other commercial loss, even if advised of the possibility of such damages.
2. Any other damages, whether incidental, consequential or otherwise.
3. Any claim against the customer by any other party.
4. Repair or attempted repair by anyone not authorized by ViewSonic.
- 5.
- 6.
- 7.

Contact Information for Sales & Authorized Service (Centro Autorizado de Servicio) within Mexico:	
Name, address, of manufacturer and importers: México, Av. de la Palma #8 Piso 2 Despacho 203, Corporativo Interpalmas, Col. San Fernando Huixquilucan, Estado de México Tel: (55) 3605-1099 http://www.viewsonic.com/la/soporte/index.htm	
NÚMERO GRATIS DE ASISTENCIA TÉCNICA PARA TODO MÉXICO: 001.866.823.2004	
Hermosillo: Distribuciones y Servicios Computacionales SA de CV. Calle Juarez 284 local 2 Col. Bugambillas C.P: 83140 Tel: 01-66-22-14-9005 E-Mail: disc2@hmo.megared.net.mx	Villahermosa: Compumantenimietnos Garantizados, S.A. de C.V. AV. GREGORIO MENDEZ #1504 COL, FLORIDA C.P. 86040 Tel: 01 (993) 3 52 00 47 / 3522074 / 3 52 20 09 E-Mail: compumantenimientos@prodigy.net.mx
Puebla, Pue. (Matriz): RENTA Y DATOS, S.A. DE C.V. Domicilio: 29 SUR 721 COL. LA PAZ 72160 PUEBLA, PUE. Tel: 01(52).222.891.55.77 CON 10 LINEAS E-Mail: datos@puebla.megared.net.mx	Veracruz, Ver.: CONEXION Y DESARROLLO, S.A DE C.V. Av. Americas # 419 ENTRE PINZÓN Y ALVARADO Fracc. Reforma C.P. 91919 Tel: 01-22-91-00-31-67 E-Mail: gacosta@qplus.com.mx
Chihuahua Soluciones Globales en Computación C. Magisterio # 3321 Col. Magisterial Chihuahua, Chih. Tel: 4136954 E-Mail: Cefeo@soluglobales.com	Cuernavaca Compusupport de Cuernavaca SA de CV Francisco Leyva # 178 Col. Miguel Hidalgo C.P. 62040, Cuernavaca Morelos Tel: 01 777 3180579 / 01 777 3124014 E-Mail: aquevedo@compusupportcva.com
Distrito Federal: QPLUS, S.A. de C.V. Av. Coyoacán 931 Col. Del Valle 03100, México, D.F. Tel: 01(52)55-50-00-27-35 E-Mail : gacosta@qplus.com.mx	Guadalajara, Jal.: SERVICRECE, S.A. de C.V. Av. Niños Héroes # 2281 Col. Arcos Sur, Sector Juárez 44170, Guadalajara, Jalisco Tel: 01(52)33-36-15-15-43 E-Mail: mmiranda@servicrece.com
Guerrero Acapulco GS Computación (Grupo Sesicomp) Progreso #6-A, Colo Centro 39300 Acapulco, Guerrero Tel: 744-48-32627	Monterrey: Global Product Services Mar Caribe # 1987, Esquina con Golfo Pérsico Fracc. Bernardo Reyes, CP 64280 Monterrey N.L. México Tel: 8129-5103 E-Mail: aydeem@gps1.com.mx
MÉRIDA: ELECTROSER Av Reforma No. 403Gx39 y 41 Mérida, Yucatán, México CP97000 Tel: (52) 999-925-1916 E-Mail: rrrb@sureste.com	Oaxaca, Oax.: CENTRO DE DISTRIBUCION Y SERVICIO, S.A. de C.V. Murguía # 708 P.A., Col. Centro, 68000, Oaxaca Tel: 01(52)95-15-15-22-22 Fax: 01(52)95-15-13-67-00 E-Mail: gpotai2001@hotmail.com
Tijuana: STD Av Ferrocarril Sonora #3780 L-C Col 20 de Noviembre Tijuana, Mexico	FOR USA SUPPORT: ViewSonic Corporation 10 Pointe Dr. Suite 200. Brea, CA. 92821 UY.S.A Tel: 800-688-6688 (English); 866-323-8056 (Spanish); E-Mail: http://www.viewsonic.com



ViewSonic®